

SERIE PROYECPLAN



ASESORAMIENTO
PERSONALIZADO

INGENIERÍA
Y PROYECTOS

SOLUCIONES
LLAVE EN MANO

EQUIPAMIENTO
INTEGRAL

ATENCIÓN
AL CLIENTE



Empresa Homologada por la
Dirección General del Patrimonio del Estado

mobiliar@mobiliar.es
www.mobiliar.es
902 365 064

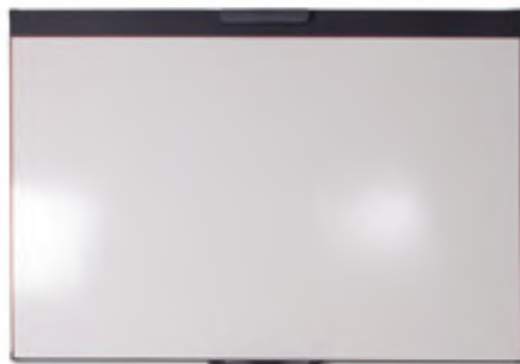

REF	whiteboard	ITV	
ITV/01	130 x 200	VDP/7/10	87
ITV/02	120 x 200	VDP/6/2	87

*Soporte para proyector incluido / Projector stand included



DISPOSITIVO INTERACTIVO

ESP Dispositivo interactivo, portátil. Convierte su pizarra blanca o verde tradicional en una PDI (Pizarra Digital Interactiva). Permite capturar instantáneamente todo lo que se escribe sobre ella y enviarlo a un PC. La escritura queda memorizada.

INTERACTIVE PORTABLE SYSTEM

ENG Interactive device, portable. Turn your whiteboard into a PDI (interactive whiteboard). Instantly Capture everything you write on it and send it to a PC. The script is stored.

BARRE PORTABLE INTÉRACTIVE

FRA Dispositif portable. Transformez votre tableau blanc ou vert traditionnel en PDI (tableau blanc interactif). Capturez instantanément tout ce que vous écrivez dessus et l'envoyer vers un PC pour y être stocké.



PACK ITV/01
DESCR.

ESP Pizarra blanca mate 130 x 200 cm.
+ Videoprojector VPD/7/10
+ Soporte

ENG Matt whiteboard 130 x 200 cm.
+ Video projector VPD/7/10
+ Support

FRA Tableau blanc mat 130 x 200 cm.
+ Vidéoprojecteur VPD/7/10
+ Support



PACK ITV/02
DESCR.

ESP Pizarra 720/6/M - 120 x 200 cm.
+ Videoprojector VPD/6/2 + Soporte
+ 1 lápiz digitales

ENG Whiteboard 720/6/M - 120 x 200 cm.
+ Video projector VPD/6/2 + Support
+ 1 digital pen

FRA Tableau 720/6/M - 120 x 200 cm.
+ Vidéoprojecteur VPD/6/2 + Support
+ 1 digital pen



MIMIO TECH

REF Características

MIMIO/T MIMIO Teach + Digital pen
MIMIO/CP Kit MIMIO Capture



KIT ITV

REF L

KIT/ITV 10 x 10 Kit conexión USB
USB kit connection
Kit connexion USB



VPD

VIDEOPROYECTORES
 VIDEOPROJECTOR
 VIDÉOPROJECTEURS



REF	L	Res.	ANSI Lumenes	REF	L	Res.	ANSI Lumenes
A VPD/1	34,9 x 24,7 x 10,5	XGA	2200	D VPD/4	35,0 x 38,2 x 14,3	XGA	2000
B VPD/2	34,9 x 24,7 x 10,5	XGA	3000	E VPD/5	32,1 x 38,5 x 17,8	WXGA	3000
C VPD/3	37,9 x 30,5 x 10,7	XGA	5000				

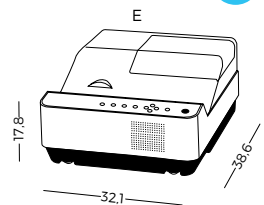
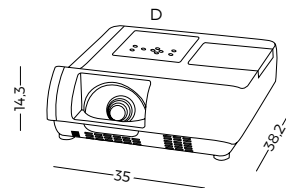
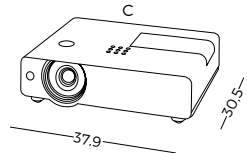
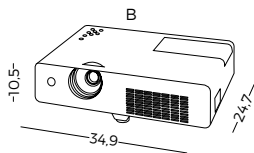
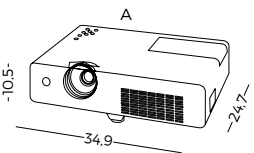

VIDEOPROYECTORES

ESP Videoproyectores compactos y portátiles de altas prestaciones indicado para instalaciones o presentaciones móviles. Éstos proyectores tienen un uso polivalente tanto para la educación como en empresas por su portabilidad, y ofrecen gran luminosidad.

VIDEO PROJECTOR

ENG Portable compact video projectors with high performance suitable for installations or mobile presentations. These projectors have a multipurpose use for education and for the company due to its portability, and offers high luminosity.

VIDÉO PROJECTEURS

FRA Gamme complète de vidéoprojecteurs polyvalent pour l'éducation et les entreprises. Performants, léger et très lumineux, vous y trouverez un produit adapté, une entrée, un moyen et un haut de gamme.



PROYECPLAN

VIDEOPROYECTORES
 VIDEOPROJECTOR
 VIDÉOPROJECTEURS

VPD



REF	L	Res.	ANSI Lumens	Touch
VPD/6/2	38,3 x 30,8 x 8,6	WXGA	3300	Bolígrafo táctil
VPD/7/10	38,3 x 30,8 x 8,6	WXGA	3300	Táctil

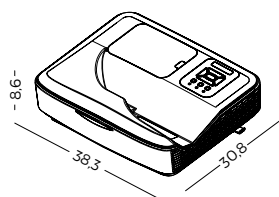

VIDEOPROYECTORES

ESP Videoproyectores compactos y portátiles de altas prestaciones indicado para instalaciones o presentaciones móviles. Éstos proyectores tienen un uso polivalente tanto para la educación como en empresas por su portabilidad, y ofrecen gran luminosidad.

VIDEO PROJECTOR

ENG Portable compact video projectors with high performance suitable for installations or mobile presentations. These projectors have a multipurpose use for education and for the company due to its portability, and offers high luminosity.

VIDÉO PROJECTEURS

FRA Gamme complète de vidéoprojecteurs polyvalent pour l'éducation et les entreprises. Performants, léger et très lumineux, vous y trouverez un produit adapté, une entrée, un moyen et un haut de gamme.



410

SOPORTES AJUSTABLES
ADJUSTABLE BRACKETS
SUPPORT PLAFOND INCLINABLE



REF	↑	→
410/06/100	8/98	22

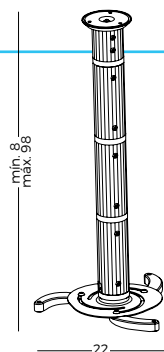

REF	↑	→
410/06	17	22

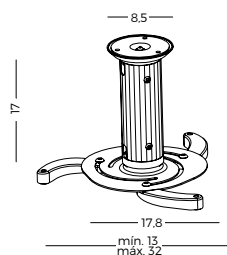

REF	↑	→
410/20	20.3	73/123

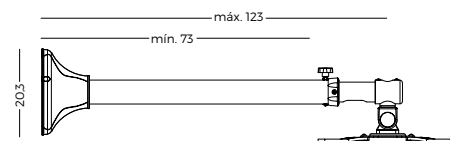

SOPORTES AJUSTABLES

ESP Soporte metálico de fijación a techo o pared para videoproyectores con un máximo de 13,6 kg. Acabado en color gris metalizado.

ADJUSTABLE BRACKETS

ENG Ceiling brackets for videoprojector up to 13,6 Kg. Suitable for most of the projectors thanks to 3 or 4 arms mounting pattern. Easy to install thanks to a hook-in system.

SUPPORTS RÉGLABLES

FRA Support métallique se fixant au plafond ou au sol pour vidéoprojecteurs jusqu'à 13,6 Kg. Finition gris métallisé.



PANTALLA CON TRÍPODE
TRIPOD PROJECTOR SCREEN
ÉCRAN DE PROJECTION SUR PIED

PT



REF	W	H	D
PT/T1	270	150 x 150	13.5
PT/T2	270	180 x 180	13.5

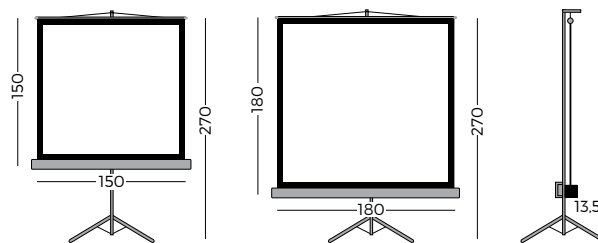

PANTALLA CON TRÍPODE "BASIC"

ESP Pantalla de proyección con trípode. La carcasa de gran diseño, está fabricada en chapa plastificada color blanco y la tela es especial antirreflectante. Posee brazo inclinable para corregir la distorsión de la imagen. Estructura plegable. Ganancia: 1.3. Tela M1.

TRIPOD PROJECTOR SCREEN "BASIC"

ENG Tripod projector screen. The design casing is made entirely of white laminated sheet metal and the fabric is antiglare. Easy to install and to use. The screen has an adjustable inclined bracket to correct image distortion. Foldable structure. Gain 1.3. Fabric M1.

ÉCRAN DE PROJECTION SUR TRÉPIED "BASIC"

FRA Écran de projection sur trépied avec potence télescopique et correction de parallaxe. Carter en tôle plastifiée blanc non réfléchissant. Grande qualité d'image, la toile blanc mat de gain 1.3 est ignifugé M1. Déroulement simple et rapide à la mesure souhaitée.



PM

PANTALLA MURAL
WALL PROJECTOR SCREEN
ÉCRAN DE PROJECTION



PANTALLA

REF	↕	↔
PM/T1	147 x 147	14
PM/T2	177 x 177	14
PM/T3	200 x 200	14
PM/T4	240 x 240	14

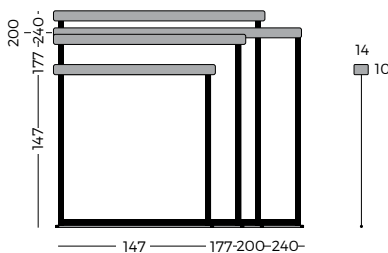

SEPARADOR DE PARED

REF	↔
SP/1	1 - 15cm
SP/2	1 - 35cm



PANTALLA MURAL "BASIC"

ESP Pantalla mural de proyección, adaptable a techo y pared. La carcasa está fabricada en chapa plastificada color blanco y la tela es especial antirreflectante. La tela se puede desenrollar a la medida deseada y el enrollado es automático. Ganancia: 1,3. Tela M1.

WALL PROJECTOR SCREEN "BASIC"

ENG Projector screen for the ceiling and wall. The design casing is made entirely of white laminated sheet metal and the fabric is anti-glare. The fabric can be unrolled to the wished measurement and the rolling up is automatic. Gain 1,3. Fabric M1.

ÉCRAN DE PROJECTION "BASIC"

FRA Écran de projection manuel, fixation murale et/ou plafond. Carter en tôle plastifiée blanc non réfléchissant. Grande qualité d'image, la toile blanc mat de gain 1,3 est ignifugé M1. Déroulement simple et rapide à la dimension souhaitée.



PROYECPLAN

PANTALLA MURAL ELÉCTRICA
ELECTRICAL PROJECTION SCREEN
ÉCRAN DE PROJECTION ÉLECTRIQUE

PMM

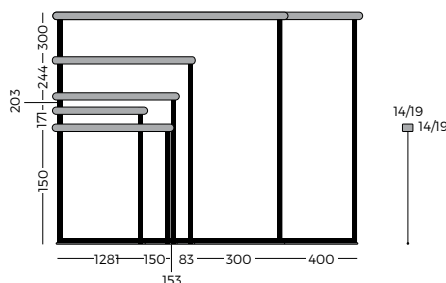

REF	Γ	Π
PMM/10	150 x 150	14
PMM/11	177 x 177	14
PMM/12	200 x 200	14
PMM/13	240 x 240	19
PMM/14	300 x 300	19
PMM/15	300 x 400	19

*Mando a distancia incluido / Remote control included



PANTALLA MURAL ELÉCTRICA

ESP Pantalla mural de elevación automática por medio de un motor eléctrico adaptable a techo y pared. La carcasa está fabricada en aluminio y la tela es especial antirreflejante. El funcionamiento de la pantalla se acciona mediante un interruptor manual.

ELECTRICAL PROJECTION SCREEN

ENG Wall or ceiling projection screen. Roll-up mechanism driven through an electrical motor. The design casing is made entirely of aluminium and the fabric is anti-glare. A manual switch (included) or remote controls (optional). Gain 1.3. Fabric M1.

ÉCRAN DE PROJECTION ÉLECTRIQUE

FRA Écran de projection motorisée. Fixation murale ou plafond. Moteur à vitesse de rotation élevée, permettant une mise en place de l'écran très rapide. Carter en aluminium anodisé de couleur gris, anti-reflets Interrupteur manuel (inclus). Gain 1,3 est ignifugé M1.



ION/Z

SOPORTE PANTALLA DE SOBREMESA
 SCREEN SUPPORT
 SUPPORT POUR ÉCRAN À POSER

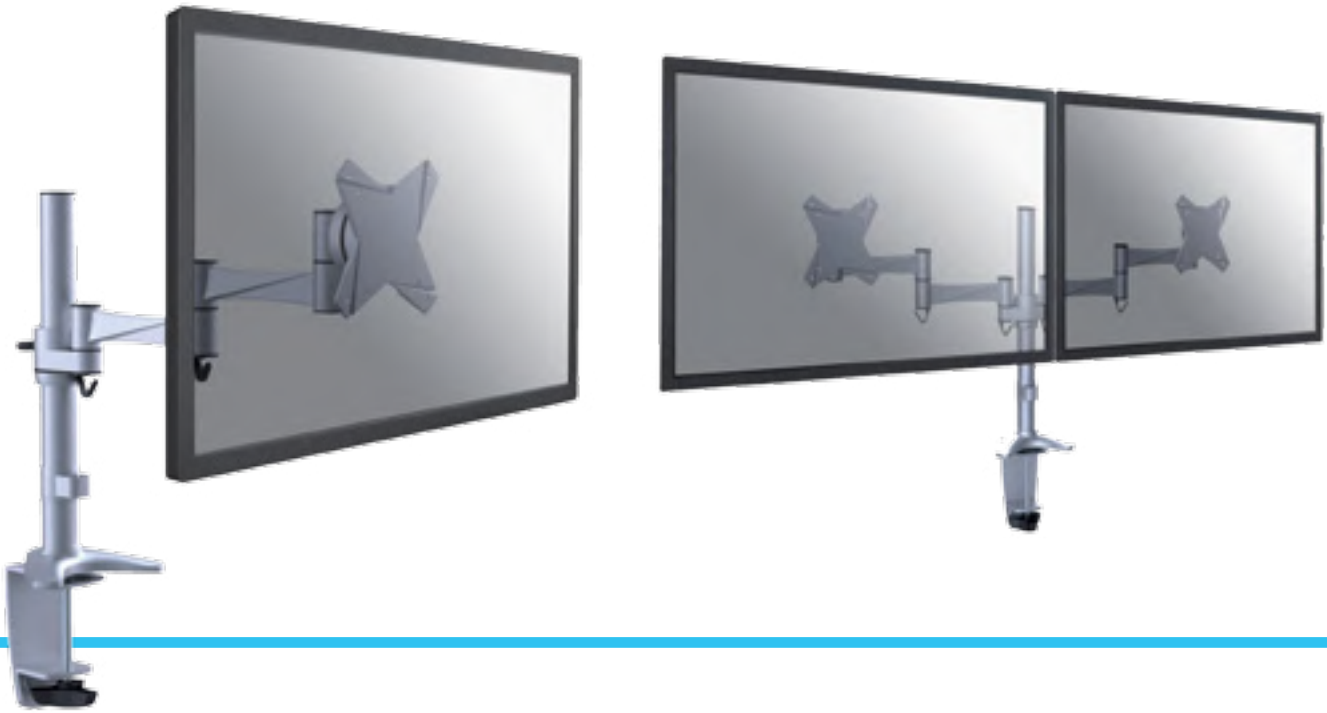

REF			VESA min.	VESA max.
ION/Z/102	51	42,7	75 x 75	100 x 100
ION/Z/102/TW	51	85,4	75 x 75	100 x 100



*Por cada soporte/ For any support

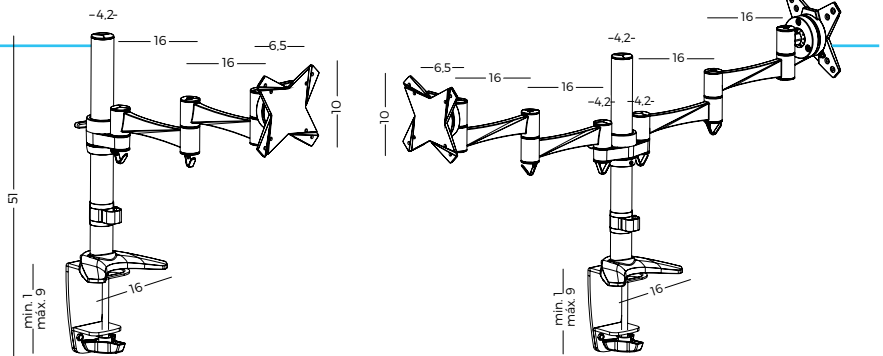

SOPORTE PANTALLA DE SOBREMESA "ZOOM"

ESP Serie ergonómica de brazos y soportes de sobremesa metálicos para pantallas de LCD / plasma hasta 24 pulgadas y un máximo de 18kg. (2 x 9kg.) Incluyen sistema de extensión VESA y clip pasacables. Acabado en color gris metalizado.

SCREEN SUPPORT "ZOOM"

ENG An ideal solution for LCD/Plasma up to 24 inch, and maximum mounting 18kg.(2 x 9kg.) distinguished by its high quality design aesthetic. Featuring an integral ball joint, it offers the possibility of rotating the screens through 360°, in addition to a tilting range of 15°, up or down. Height adjustable.

SUPPORT POUR ÉCRAN À POSER "ZOOM"

FRA Platines murales universelles et supports de table pour écrans LCD/Plasma jusqu'à 28 pouces et 20 Kg. Comprend un système d'extension VESA et un anneau passe-cables électriques. Finition gris métallisé.



SOPORTE PANTALLA MURAL
WALL BRACKETS FOR SCREENS
PLATINE MURALE POUR ÉCRAN

ION

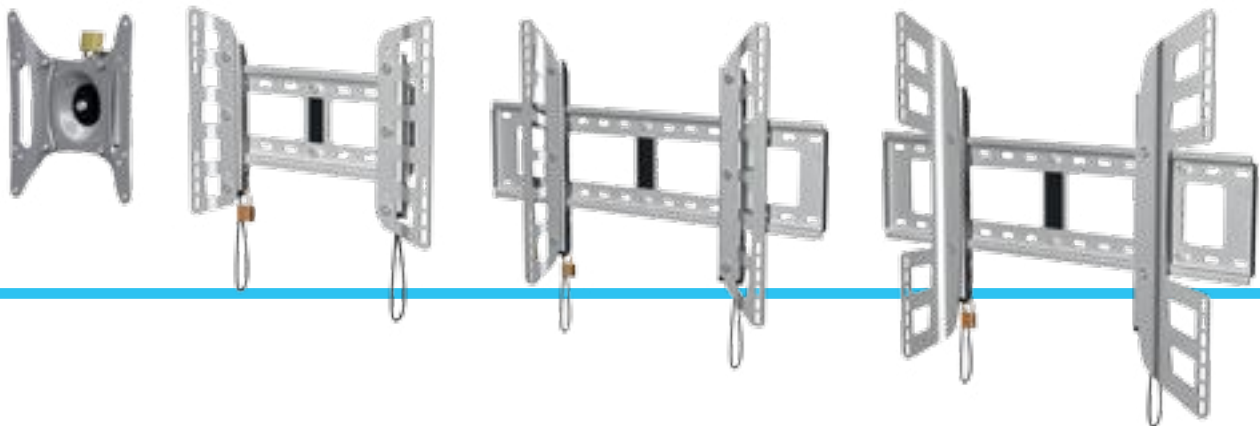

REF L +
ION/TR 22 x 20 5,8

32" máx. 30 Kg. máx.

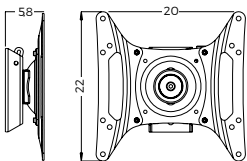

REF L +
ION/PL 33,6 x 44,4 3,7

52" máx. 75 Kg. máx.

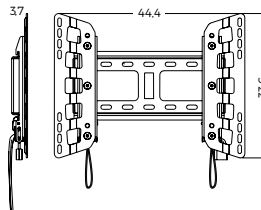

REF L +
ION/PL/XL 53 x 85 3,7

60" máx. 80 Kg. máx.

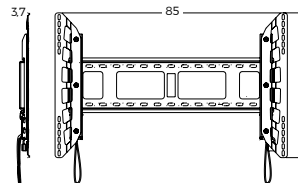

REF L +
ION/TR 60 x 85 3,7

65" máx. 80 Kg. máx.

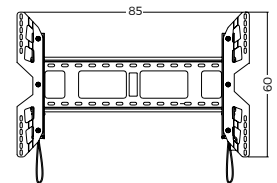
**SOPORTE PANTALLA MURAL**

ESP Serie de soportes murales metálicos para pantallas de LCD / plasma de 32 hasta 65 pulgadas y un máximo de 80 kg. Incluyen sistema de seguridad con candado. Acabado en color gris metalizado. Ideal para grandes formatos (XL y XXL).

WALL BRACKETS FOR SCREENS

ENG Wall brackets for screens up to 32 / 65 inch with a maximum weight of 80 Kg. Possibility to swivel and tilt 30°. Equipped with security lock.

PLATINE MURALE POUR ÉCRAN

FRA Platines murales métalliques pour écrans LCD/Plasma jusqu'à 32 / 65 pouces et un maximum de 80 Kg. Comprend un système de sécurité avec cadenas. Finitions gris métallisé.



CEILING

SOPORTE LCD/PLASMA DE TECHO
CEILINGS BRACKETS LCD/PLASMA
SUPPORT PLAFOND POUR ÉCRAN

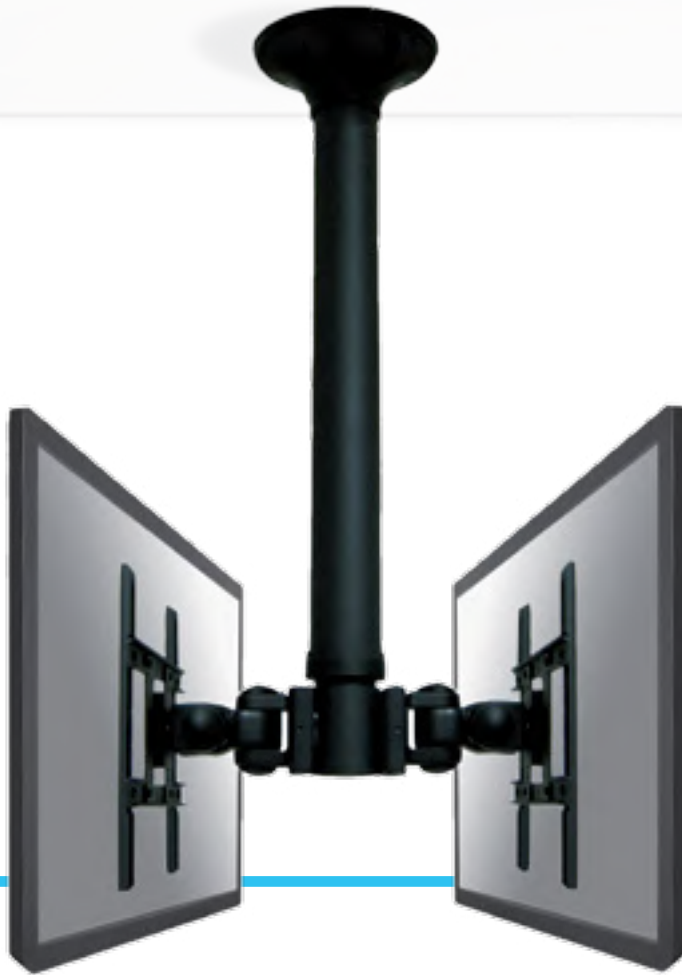

REF | — VESA min. VESA max.

ION/C/XL	64/104	16	75 x 75	200 x 200
ION/C/TW/XL	64/104	32,5	75 x 75	200 x 200



*Por cada soporte/ For any support

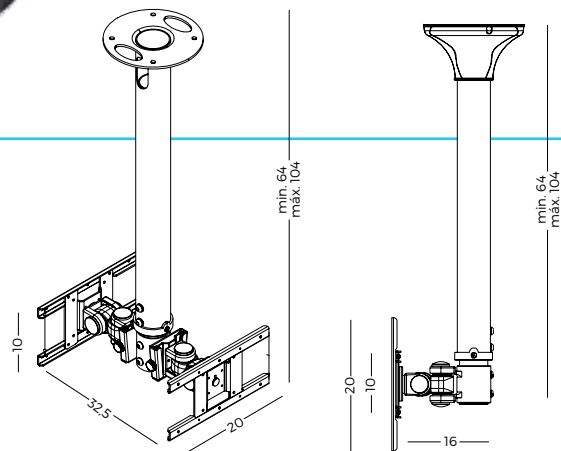

SOPORTE LCD/PLASMA DE TECHO "CEILING"

ESP Serie ergonómica de brazos y soportes metálicos de fijación suspendida a techo, para pantallas de LCD / plasma hasta 40 pulgadas y un máximo de 20 kg. Incluyen sistema de extensión VESA y clip pasacables. Acabado en color gris metalizado.

CEILINGS BRACKETS LCD/PLASMA "CEILING"

ENG Ceilings brackets for LCD/Plasma screens until 40 inch VESA extension for a maximum mounting 20 kg. Adjustable height.

SUPPORT PLAFOND POUR ÉCRAN "CEILING"

FRA Supports plafond sur platine pour écrans LCD/Plasma jusqu'à 40 pouces et 20 Kg. Comprend un système d'extension VESA et des goulottes pour câbles électriques. Finition gris métallisé.



SOPORTE PARA TV GRADUABLE Y MÓVIL
SUPPORT FOR ADJUSTABLE AND MOBILE TV
SUPPORT POUR ÉCRAN

TVS

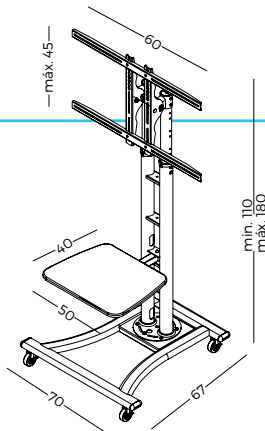

COLOR ESTANTE



REF L Shelf VESA min. VESA max.

TVS/N 180 x 110 1 200 x 200 600 x 450



SOPORTE PARA TV GRADUABLE Y MÓVIL

ESP Soporte móvil para TV, pantalla y monitores de gran robustez, que incorpora un estante graduable en altura. Disponible en color gris y negro. Ideal para salas de formación, centros de convenciones, etc... Incluye estante.

SUPPORT FOR ADJUSTABLE AND MOBILE TV

ENG Mobile stand for TV screen and monitors really robust, incorporating or adjustable height shelf. Available in grey and black. Ideal for training rooms, convention halls, etc... Shelf included.

SUPPORT POUR ÉCRAN

FRA Support mobile pour écrans de télévision et moniteurs très robuste, incorpore une étagère réglable en hauteur. Disponible en gris et noir. Idéal pour les salles de formation, centres de congrès, etc...



TROLEY

MESAS DE PROYECCIÓN
PROJECTOR TROLLEYS
TABLES DE RÉTROPROJECTION



REF † ‡ †‡

A	MM	60/95	60 x 55	1,9
B	MP	60/95	60 x 55	1,9

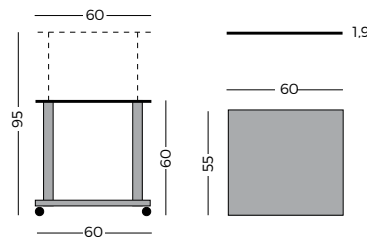

A

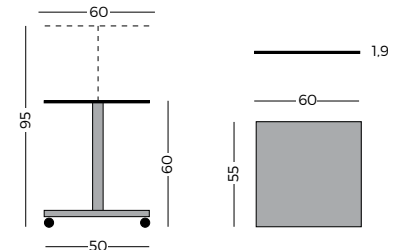

B

MESAS DE PROYECCIÓN

ESP Mesa de proyección cómoda y ligera, con ruedas multidireccionales, provistas de freno las delanteras. Toda la gama de mesas tienen la estructura metálica pintada en color gris, y los tableros son de madera melaminada.

PROJECTOR TROLLEYS

ENG With a modern design suitable for all OHPs, this functional grey metallic mobile trolley features a laminated tabletop for storage of accessories and equipment, and 4 fully circular castors (lockable front castors).

TABLES DE RÉTROPROJECTION

FRA Table de projection légère et stable. Conception en métal gris et plateau en mélaminé. Equipée de 4 roulettes pivotantes dont 2 avec freins, qui assurent mobilité et stabilité. Plateau télescopique réglable en hauteur. Idéale pour n'importe quel type de projecteur



ATRIL Y SOPORTE PORTA IPAD
LECTERN AND IPAD HOLDER SUPPORT
CHEVALET ET SUPPORTS POUR IPAD

600

**DE PIE**

REF	Tablet	↑	└
600/IP/NG	23 x 28	110	36 x 36
600/IP/BL	23 x 28	110	36 x 36

DE PARED

REF	Tablet	↑
600/IM/NG	23 x 28	40
600/IM/BL	23 x 28	40

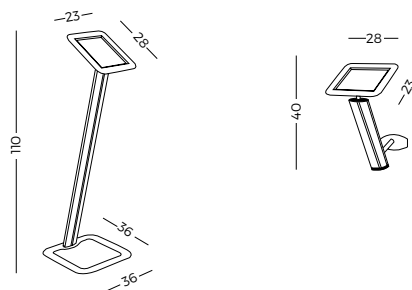
**ATRIL Y SOPORTE PORTA IPAD**

ESP Gama de atriles y soportes de aluminio porta iPad. Disponible en versión de pié y mural. Ideal para comercios, showrooms, ferias y convenciones. El sistema incorpora dispositivo de seguridad antirrobo.

LECTERN AND IPAD HOLDER SUPPORT

ENG Range of lectern and display in aluminium tube for iPad holder. Available in wall and floor versions. Ideal for shops, showrooms, exhibitions and conventions. The system incorporates anti-theft device.

CHEVALET ET SUPPORTS POUR IPAD

FRA Gamme de chevalet et supports en aluminium tubulaire pour iPad. Disponible en version murale et sur pié. Idéal pour magasins, salles d'exposition, salons et congrès. Le système comprend un antivol.



ICONOS

ICONOS
ICONS
ICONES



Rotulable
Inscribable
Inscriptable



No rotulable
Not inscribable
Non-inscriptable



Escritura con tiza
Chalk writing
Escriture à la craie



Trazo digital
Digital use
Trait digital



Blocs de papel
Paper blocs
Blocs du papier



Personalizable
Customizable
Personnalisé



Magnético
Magnetic
Magnétique



No magnético
Not magnetic
Non-magnétique



Perforable
Suitable for pins
Aptes aux punaises



Adhesivo
Adhesive
Adhésif



Doble cara
Double sided
Double face



Sujección incluida
Fitting included
Ferrures inclus



Puerta abatible vert.
Vert. swing door
Portes battante vert.



Puerta abatible hor.
Hor. swing door
Portes battante hor.



Incluye ruedas
Castors included
Avec roulettes



Incluye nivelador
Adjustable base
Socles ajustables



Ajustable en altura
Adjustable height
Régable en hauteur

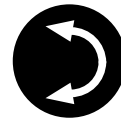

Volteable
Flip - flop
Volteable



Puerta corredera
Sliding doors
Portes coulissantes



Incluye cerradura
Lock included
Serrure incluse



Sistema seguridad
Security system
Serrure de sécurité



Resistente
Weatherproof
Résistant



Inflamable
Flammable
Inflammable



Kit de iluminación
Light kit
Kit lumière

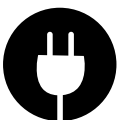

Incluye cable
Cable included
Câbles inclus



Incluye herramientas
Tools included
Visserie inclus

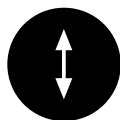

Incluye nivelador
Adjustable base
Socles ajustables



Acústico
Acoustic
Acoustique

1 Borrador en seco
Dry - wipe
Effaçables à sec

2 Doble cara
Double sided
Double face

3 Colores
Colours
Couleurs



Empresa Homologada por la
Dirección General del Patrimonio del Estado

mobiliar@mobiliar.es
www.mobiliar.es
902 365 064



CENTRAL

C/ La Fragua, 5 • Edificio Mobiliar • Pl. "Los Rosales"
Tel.: 916 656 230 • Fax: 916 641 506
28933 Móstoles (Madrid)

DELEGACIÓN

C/ Pere el Ceremonios, 3 • Nave 2 • Pl. "Masía de Espí"
Tel.: 961 534 064 • Fax: 961 537 790
46930 Quart de Poblet (Valencia)

FÁBRICA

Avda. de las Retamas, s/n • Pl. "Monte Boyal"
Tel.: 918 171 744 • Fax: 918 170 952
45950 Casarrubios del Monte (Toledo)