

SERIE MODULARES



ASESORAMIENTO
PERSONALIZADO

INGENIERÍA
Y PROYECTOS

SOLUCIONES
LLAVE EN MANO

EQUIPAMIENTO
INTEGRAL

ATENCIÓN
AL CLIENTE



Empresa Homologada por la
Dirección General del Patrimonio del Estado

mobiliar@mobiliar.es
www.mobiliar.es
902 365 064

TAQUILLAS MODULARES

DISASSEMBLED LOCKERS /

VESTIAIRES DEMONTABLES /

ARMÁRIOS DE VESTIÁRIO DESMONTÁVEIS /



SERIE AV

SERIE AV	↑	↔	kg	M ³	↔	kg	M ³	↗
AV-25	1800	280	19,2	0,096	250	13,2	0,077	510
AV-30	1800	330	21,5	0,096	300	15,5	0,077	510
AV-35	1800	380	22,8	0,096	350	16,8	0,077	510
AV-40	1800	430	26,5	0,096	400	20,5	0,077	510
AV-45	1800	480	27,9	0,096	450	21,9	0,077	510



(AV-25, AV-30, AV-35) (AV-40, AV-45)

AV-25/1
COD. 32501

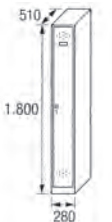

kg • M³ 19,2 • 0,26

AV-25/2
COD. 32502



32,4 • 0,49

AV-25/3
COD. 32503



45,5 • 0,72

AV-25/4
COD. 32504



58,7 • 0,95

AV-30/1
COD. 33001



21,5 • 0,30

AV-30/2
COD. 33002

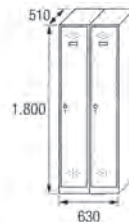

37,0 • 0,58

AV-30/3
COD. 33003



52,5 • 0,85

AV-30/4
COD. 33004



68,0 • 1,13

AV-35/1
COD. 33501



22,8 • 0,35

AV-35/2
COD. 33502



39,6 • 0,67

AV-35/3
COD. 33503



56,4 • 0,99

AV-40/1
COD. 34001



26,5 • 0,39

AV-40/2
COD. 34002

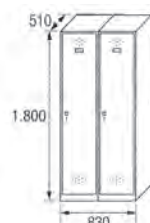

47,0 • 0,76

AV-40/3
COD. 34003

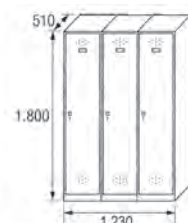

67,5 • 1,13

AV-45/1
COD. 34501

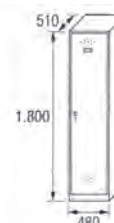

27,9 • 0,44

AV-45/2
COD. 34502



49,8 • 0,85

SERIE AT

SERIE AT	↑↓	↔	kg	M ³	↔	kg	M ³	↗↘
AT-25	1800	280	19,9	0,096	250	13,9	0,077	510
AT-30	1800	330	21,1	0,096	300	15,1	0,077	510
AT-35	1800	380	22,7	0,096	350	16,7	0,077	510
AT-40	1800	430	25,0	0,096	400	19,0	0,077	510



AT-25/1
COD. 32511

AT-25/2
COD. 32512

AT-25/3
COD. 32513

AT-25/4
COD. 32514

AT-30/1
COD. 33011

AT-30/2
COD. 33012

AT-30/3
COD. 33013

AT-30/4
COD. 33014

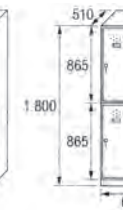
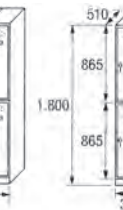
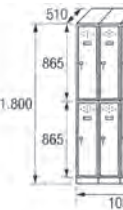
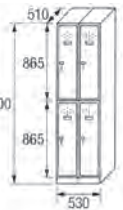
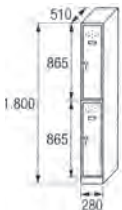

kg M³ 19,9 • 0,26

33,8 • 0,49

47,7 • 0,72

61,6 • 0,95

21,1 • 0,30

36,2 • 0,58

51,3 • 0,85

66,4 • 1,13

AT-35/1
COD. 33511

AT-35/2
COD. 33512

AT-35/3
COD. 33513

AT-40/1
COD. 34011

AT-40/2
COD. 34012

AT-40/3
COD. 34013

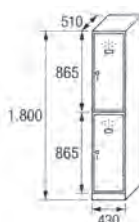
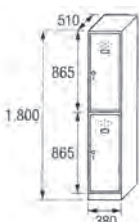

kg M³ 22,7 • 0,35

39,4 • 0,67

56,1 • 0,99

25,0 • 0,39

44,0 • 0,76

63,0 • 1,13

SERIE AM



SERIE AM	↑	↔	kg	M ³	↔	kg	M ³	↗
AM-25	1800	280	20,9	0,096	250	14,9	0,077	510
AM-30	1800	330	22,2	0,096	300	16,2	0,077	510
AM-35	1800	380	23,7	0,096	350	17,7	0,077	510
AM-40	1800	430	25,2	0,096	400	19,2	0,077	510



AM-25/1
COD. 32531

AM-25/2
COD. 32532

AM-25/3
COD. 32533

AM-25/4
COD. 32534

AM-30/1
COD. 33031

AM-30/2
COD. 33032

AM-30/3
COD. 33033

AM-30/4
COD. 33034

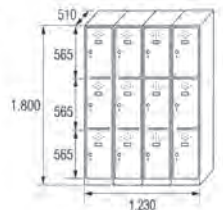
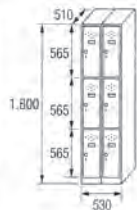
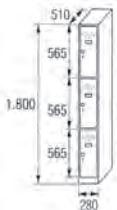

kg • M³ 20,9 • 0,26

35,8 • 0,49

50,6 • 0,72

65,5 • 0,95

22,2 • 0,30

38,4 • 0,58

54,6 • 0,85

70,8 • 1,13

AM-35/1
COD. 33531

AM-35/2
COD. 33532

AM-35/3
COD. 33533

AM-40/1
COD. 34031

AM-40/2
COD. 34032

AM-40/3
COD. 34033

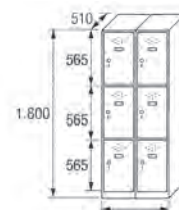
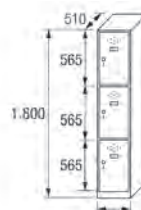
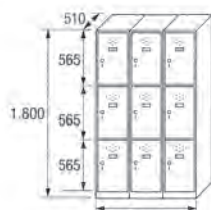
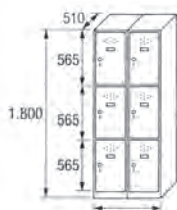
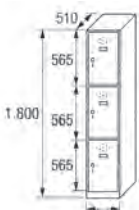

kg • M³ 23,7 • 0,35

41,4 • 0,67

59,1 • 0,99

25,2 • 0,39

44,4 • 0,76

63,6 • 1,13

SERIE AC

SERIE AC	↑↓	↔	kg	M ³	↔	kg	M ³	↗↘
AC-25	1800	280	21,8	0,096	250	15,8	0,077	510
AC-30	1800	330	23,3	0,096	300	17,3	0,077	510
AC-35	1800	380	25,08	0,096	350	19,08	0,077	510
AC-40	1800	430	26,7	0,096	400	20,7	0,077	510



AC-25/1
COD. 32521

AC-25/2
COD. 32522

AC-25/3
COD. 32523

AC-25/4
COD. 32524

AC-30/1
COD. 33021

AC-30/2
COD. 33022

AC-30/3
COD. 33023

AC-30/4
COD. 33024

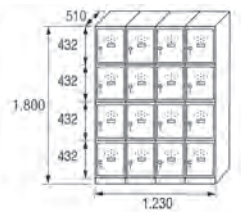
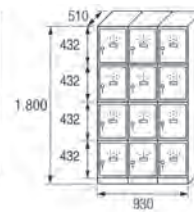
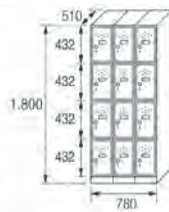
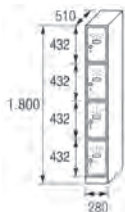

kg • M³ 21,8 • 0,26

37,6 • 0,49

53,4 • 0,72

69,2 • 0,95

23,3 • 0,30

40,7 • 0,58

58,0 • 0,85

75,4 • 1,13

AC-35/1
COD. 33521

AC-35/2
COD. 33522

AC-35/3
COD. 33523

AC-40/1
COD. 34021

AC-40/2
COD. 34022

AC-40/3
COD. 34023

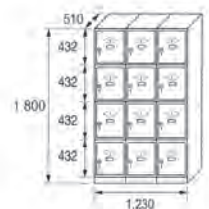
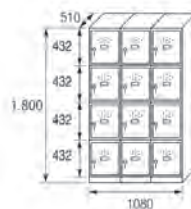

kg • M³ 25,08 • 0,35

44,16 • 0,67

63,24 • 0,99

26,7 • 0,39

47,4 • 0,76

68,1 • 1,13

SERIE AP

SERIE AP	↑↓	↔	kg	M ³	↔	kg	M ³	↗↘
AP-25	1800	280	22,7	0,096	250	16,7	0,077	510
AP-30	1800	330	24,4	0,096	300	18,5	0,077	510
AP-40	1800	430	28,1	0,096	400	22,1	0,077	510

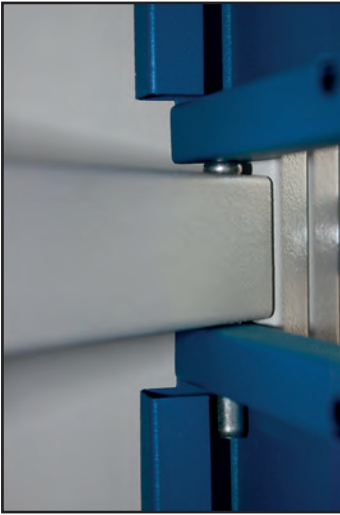

AP-25/1
COD. 32551

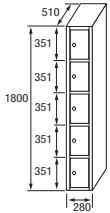

22,7 • 0,26

AP-25/2
COD. 32552

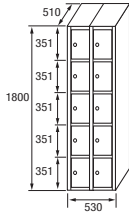

39,4 • 0,49

AP-25/3
COD. 32553

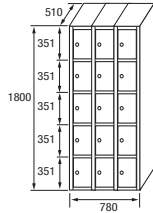

56,1 • 0,72

AP-25/4
COD. 32554

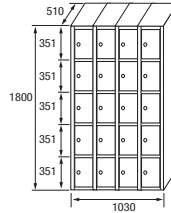

72,8 • 0,95

AP-30/1
COD. 33051

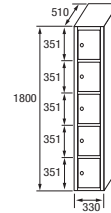

24,4 • 0,30

AP-30/2
COD. 33052

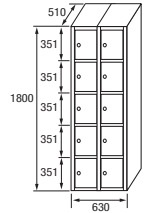

42,9 • 0,58

AP-30/3
COD. 33053

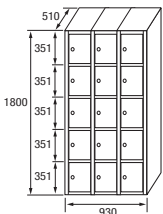

61,3 • 0,85

AP-30/4
COD. 33054

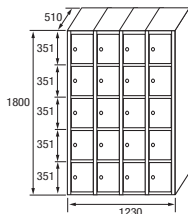

79,8 • 1,13

AP-40/1
COD. 34051

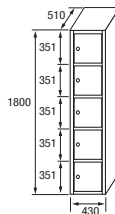

28,1 • 0,39

AP-40/2
COD. 34052

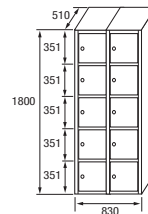

50,2 • 0,76

AP-40/3
COD. 34053

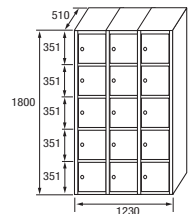

72,3 • 1,13

SERIE AB



SERIE AB	↑↓	↔	kg	M ³	↔	kg	M ³	↗↘
AB-25	1800	280	23,6	0,096	250	17,6	0,077	510
AB-30	1800	330	25,5	0,096	300	19,6	0,077	510
AB-40	1800	430	29,1	0,096	400	22,1	0,077	510



AB-25/1
COD. 32561

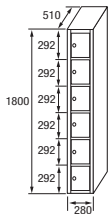

kg M³ 23,6 • 0,26

AB-25/2
COD. 32562

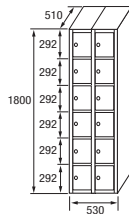

41,2 • 0,49

AB-25/3
COD. 32563

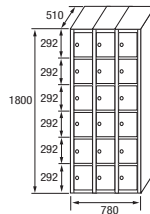

58,8 • 0,72

AB-25/4
COD. 32564

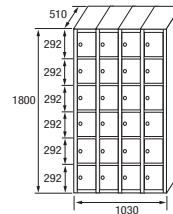

76,4 • 0,95

AB-30/1
COD. 33061

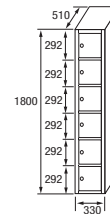

25,5 • 0,30

AB-30/2
COD. 33062

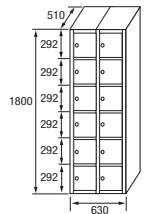

45,1 • 0,58

AB-30/3
COD. 33063

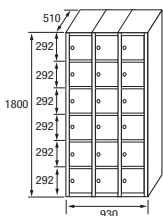

kg M³ 64,6 • 0,85

AB-30/4
COD. 33064

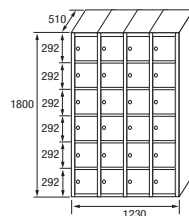

84,2 • 1,13

AB-40/1
COD. 34061

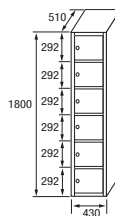

29,1 • 0,39

AB-40/2
COD. 34062

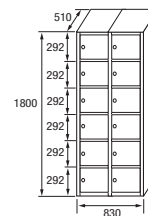

51,2 • 0,76

AB-40/3
COD. 34063

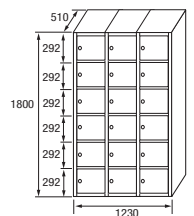

73,3 • 1,13

SERIE AZ

SERIE AZ	↑↓	↔	kg	M ³	↔	kg	M ³	↗↘
AZ-25	1800	280	25,4	0,096	250	19,4	0,077	510
AZ-30	1800	330	27,7	0,096	300	21,8	0,077	510
AZ-40	1800	430	31,9	0,096	400	24,9	0,077	510



AZ-25/1
COD. 32581

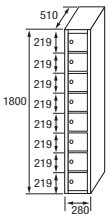

25,4 • 0,26

AZ-25/2
COD. 32582

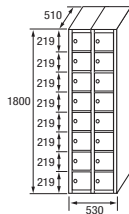

44,8 • 0,49

AZ-25/3
COD. 32583

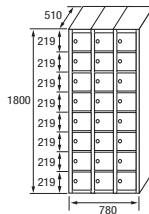

64,2 • 0,72

AZ-25/4
COD. 32584

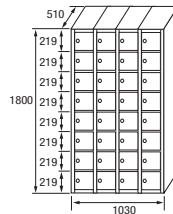

83,6 • 0,95

AZ-30/1
COD. 33081

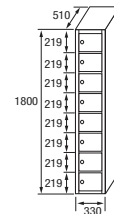

27,7 • 0,30

AZ-30/2
COD. 33082

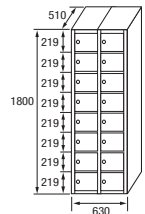

49,5 • 0,58

AZ-30/3
COD. 33083

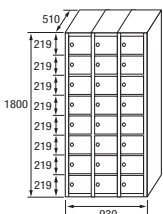

71,2 • 0,85

AZ-30/4
COD. 33084

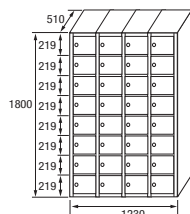

93 • 1,13

AZ-40/1
COD. 34081

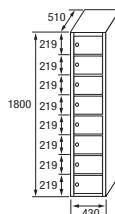

31,9 • 0,39

AZ-40/2
COD. 34082

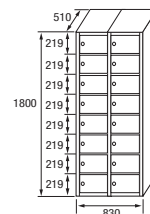

56,8 • 0,76

AZ-40/3
COD. 34083

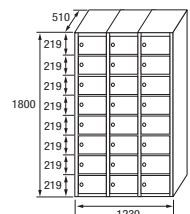

81,7 • 1,13

SERIE AL

NOVEDAD
 NEW-NOVEUTÉ·NOVIDADE

SERIE AL	↑↓	↔	kg	M ³	↔	kg	M ³	↗↘
AL-30	1800	300	24,4	0,096	300	18,5	0,077	500
AL-40	1800	400	28,1	0,096	400	22,1	0,077	500



AL-30/1
 COD. 35301

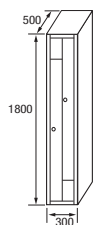

24,4 • 0,27

AL-30/2
 COD. 35302

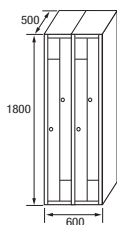

42,9 • 0,54

AL-30/3
 COD. 35303

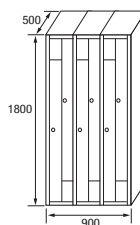

61,3 • 0,81

AL-30/4
 COD. 35304

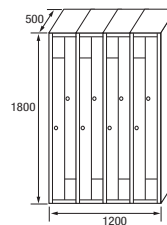

79,80 • 1,08



AL-40/1
 COD. 35401

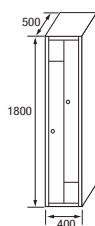

28,1 • 0,36

AL-40/2
 COD. 35402

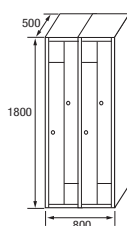

50,2 • 0,72

AL-40/3
 COD. 35403

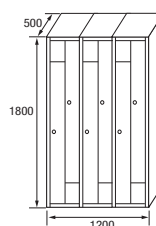

72,3 • 1,08



SERIE GYM

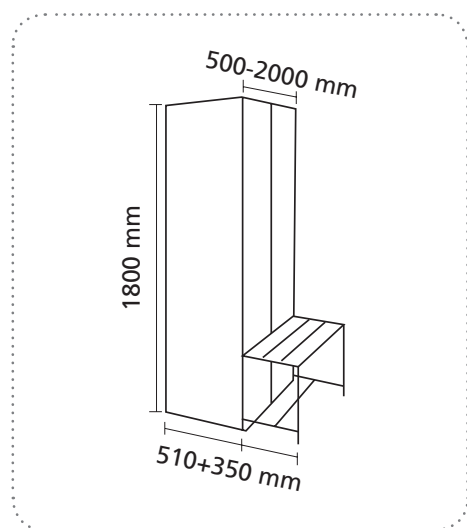

Doble fondo oculto
Covered double floor
Double fond occulte
Fundo do cacifo oculto



SERIE CHASIS

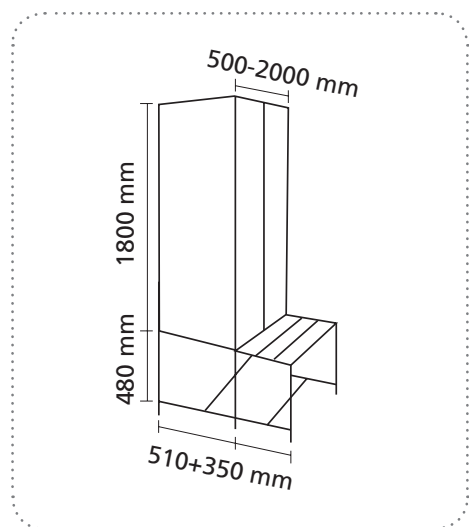

Opción: Banco retráctil
Option: Retractable bench
Option: banc rétractable
Opção: Banco retrátil



CARACTERÍSTICAS / CHARACTERISTICS / CARACTERISTIQUES / CARACTERISTICAS



Sistema inicial y de extensiones.
Initial + adds system.
Système de case départ plus cases suivantes.
Sistema de cacifo inicial e sucesivos.



Sin tornillos.
Without screws.
Sans vis.
Sem parafusos.



Microtexturado.
Microtextured.
Microtexturé.
Microtexturado.



Fácil montaje.
Easy assembly.
Montage facile.
Facil montagem.

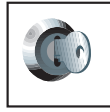

Cerradura de llave.
Standard key lock.
Serrure standard à clé.
Fechadura standard de chave.



Cuerpo gris y puertas azul.
Grey body and blue doors.
Corp gris et portes bleu.
Corpo cinza e portas azuis.



No es recomendable para espacios húmedos.
Not recommended for wet spaces.
Pas recommandé pour les environnements humides.
Nao é recomendável para lugares com humidade.



Metal.
Metal.
Metal.
Metal.



Gran resistencia.
Great resistance.
Très résistant.
Muito resistente.



Etiquetero y tirador integrado.
Card holder and handle in one piece.
Porte-étiquette avec tireur.
Portas com etiqueteiro e com tirador.



Pintado en Epoxi.
Painted in Epoxy.
Peinture en epoxi.
Pintura em epoxi.



Rosetas de ventilación.
Ventilation rosetter.
Volets d'aération.
Com ventilação.



Llave abisagrada.
Hinged key.
Clés articulés.
Chaves com articulação.



Pintura antibacteriana
Antibacterial paint
De la peinture antibactérienne
Tinta antibacteriana

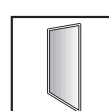

Espejo
Mirror
Miroir
Espelho

OPCIONES / OPTIONS / OPTIONS / OPÇÕES

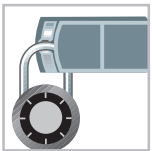

Pomo metálico (candado combinación opcional)
Padlockable Metallic Lock (optional combination padlock)
Poignée métallique (cadenas à combinaison en option)
Fechadura de cadeado em metal



Cerradura de combinación y llave de emergencia
Lock of 4 manual digits with emergency key
Serrure à combinaison et clé de émergence
Fechadura de combinação e chave de emergência



Monedero (moneda retornable).
Coin-operated Lock (coin-return).
Monnaieur (monnaie réversible).
Moedeiro (moeda retornável).



Monedero + cajetín depósito.
Coin-operated Lock + Coin Collect Box (cash box, non coin-return).
Monnaieur + tirelire (monnaie non réversible).
Moedeiro + caixinha para as moedas.



Ranura buzón. Puertas sin ventilación
Mailbox Slot. Doors without vent system
Rainure pour boîte à lettres.
Portes sans volet d'aération
Obertura para cartas. Portas sem ventilação

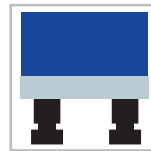

Patas regulables en PVC
Adjustable PVC Legs
Pieds réglables en PVC
Pés reguláveis em altura em PVC



Patas en acero galvanizado
Galvanized steel legs
Pieds en acier galvanisé
Pés em aço galvanizado

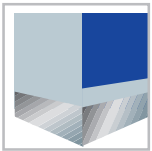

Zócalo inoxidable
Stainless Steel Front Base and End Base
Socle inoxydable
Soclo inox

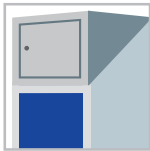

Altillo taquilla
Upper small joined locker
Casier en réhausse
Pequeno cacifo para pôr encima do armário de vestiário



Lateral embellecedor
Decorative end panel
Enjoliveur latéral
Lateral de finição

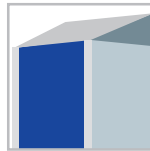

Sobretecho inclinado
Slope Top
Toit incliné
Sobreteito com pequena inclinação

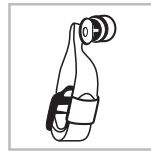

Pulsera de nylon
Bracelet of nylon
Bracelet en nylon
Pulseira de náilon



Pulsera elástica
Elastic Bracelet
Bracelet élastique
Pulseira elástica

COLORES OPCIONALES / OPTIONAL COLOURS / COULEURS EN OPTION / CORES OPCIONAIS

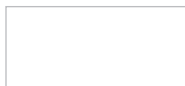

RAL 9010



RAL 6029

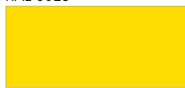

RAL 1021



RAL 1017



RAL 3000



RAL 3005



RAL 6034



RAL 5015



RAL 5023



RAL 2004



RAL 7016



RAL 7036



RAL 9006



RAL 9005



R1



R2



R3



R4



R5

COLORES REFLECTANTES
REFLECTING COLOURS
DES COULEURS RÉFLECHISSANTES
COR REFLETIVO



Empresa Homologada por la
Dirección General del Patrimonio del Estado

mobiliar@mobiliar.es
www.mobiliar.es
902 365 064



CENTRAL

C/ La Fragua, 5 • Edificio Mobiliar • Pl. "Los Rosales"
Tel.: 916 656 230 • Fax: 916 641 506
28933 Móstoles (Madrid)

DELEGACIÓN

C/ Pere el Ceremonios, 3 • Nave 2 • Pl. "Masía de Espí"
Tel.: 961 534 064 • Fax: 961 537 790
46930 Quart de Poblet (Valencia)

FÁBRICA

Avda. de las Retamas, s/n • Pl. "Monte Boyal"
Tel.: 918 171 744 • Fax: 918 170 952
45950 Casarrubios del Monte (Toledo)