

# SERIE CONSIGNAS



ASESORAMIENTO  
PERSONALIZADO

INGENIERÍA  
Y PROYECTOS

SOLUCIONES  
LLAVE EN MANO

EQUIPAMIENTO  
INTEGRAL

ATENCIÓN  
AL CLIENTE



Empresa Homologada por la  
Dirección General del Patrimonio del Estado

[mobiliar@mobiliar.es](mailto:mobiliar@mobiliar.es)  
[www.mobiliar.es](http://www.mobiliar.es)  
902 365 064

# CONSIGNAS / LEFT-LUGGAGE LOCKERS / CONSIGNES / CACIFOS /



**BANCO**



**MINI**



**SUPERMERCADO  
VERTICAL**



**SUPERMERCADO  
METACRILATO**



**SUPERMERCADO  
HORIZONTAL**



**MARCO AMARRE**



**MONOBLOK  
METACRILATO**



**GOLF**



**MALETAS**

# SERIE BANCO /

BANCO SERIES /  
 SÉRIE BANCO /  
 SÉRIE BANCO /

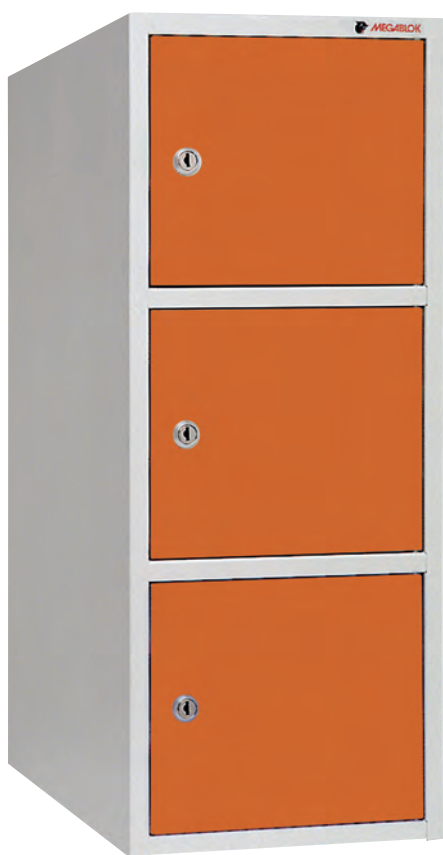

**MOD. TBC03P**  
 COD. 91300



**MOD. CBC04P**  
 COD. 91402

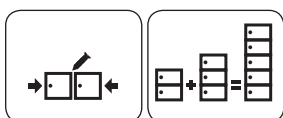

COD.	MOD.	↑	↔	↗	□	🔑	🚒	📊	M <sup>3</sup>
91400	TBC04P	915	275	440	4	✓	–	16,0	0,11
91402	CBC04P	915	275	440	4	–	✓	17,5	0,11
91300	TBC03P	690	275	440	3	✓	–	13,0	0,08
91302	CBC03P	690	275	440	3	–	✓	14,0	0,08

Unidades en milímetros / Units in milimeters / Unités en millimètres / Unidades em milímetros

# SERIE MINI /

MINI SERIES /  
SÉRIE MINI /  
SÉRIE MINI /



**MOD. TMIN4P**  
COD. 91200



**MOD. CMIN3P**  
COD. 91102

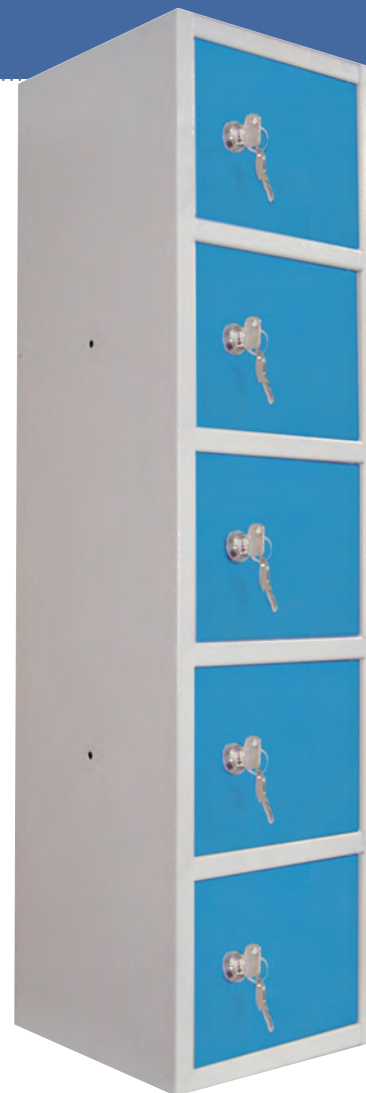

**MOD. MINI5P**  
COD. 91000

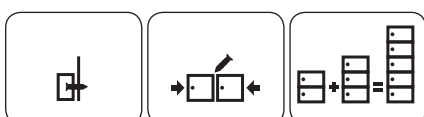

COD.	MOD.	↑	↔	↗	□	🔒	👤	🏋️	M <sup>3</sup>
91200	TMIN4P	915	275	200	4	✓	–	13,5	0,05
91202	CMIN4P	915	275	200	4	–	✓	12,0	0,05
91100	TMIN3P	690	275	200	3	✓	–	9,0	0,04
91102	CMIN3P	690	275	200	3	–	✓	10,0	0,04
91000	MINI5P	750	200	200	5	✓	–	9,0	0,03

Unidades en milímetros / Units in millimeters / Unités en millimètres / Unidades em milímetros

# SERIE SUPERMERCADO VERTICAL /

SUPERMERCADO VERTICAL SERIES /  
SÉRIE SUPERMERCADO VERTICAL /  
SÉRIE SUPERMERCADO VERTICAL /



**MOD. TSVS2P**  
COD. 95400



**MOD. CSVZ2P**  
COD. 95302



**MOD. CSVS1P**  
COD. 95502

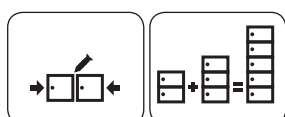

COD.	MOD.	↑	↔	↗	□	🔒	👤	📊	M <sup>3</sup>
95300	TSVZ2P	925	300	400	2	✓	–	13,0	0,11
95302	CSVZ2P	925	300	400	2	–	✓	14,0	0,11
95400	TSVS2P	800	300	400	2	✓	–	12,0	0,10
95402	CSVS2P	800	300	400	2	–	✓	13,0	0,10
95500	TSVS1P	400	300	400	1	✓	–	7,0	0,05
95502	CSVS1P	400	300	400	1	–	✓	7,5	0,05

Unidades en milímetros / Units in millimeters / Unités en millimètres / Unidades em milímetros

# SERIE SUPERMERCADO METACRILATO/

SUPERMERCADO METACRILATO SERIES /  
SÉRIE SUPERMERCADO METACRILATO /  
SÉRIE SUPERMERCADO METACRILATO /



**MOD. CSVS1PME**  
COD. 95503



**MOD. CSVS2PME**  
COD. 95403



**MOD. TSVZ2PME**  
COD. 95333

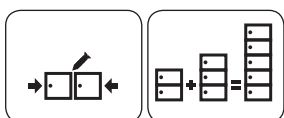

COD.	MOD.	↑	↔	↗	□	🔒	👤	📏	⚖️	M <sup>3</sup>
95333	TSVZ2PME	925	300	400	2	✓	–	14,0	0,11	
95303	CSVZ2PME	925	300	400	2	–	✓	15,0	0,11	
95433	TSVS2PME	800	300	400	2	✓	–	13,0	0,10	
95403	CSVS2PME	800	300	400	2	–	✓	14,0	0,10	
95533	TSVS1PME	400	300	400	1	✓	–	8,0	0,05	
95503	CSVS1PME	400	300	400	1	–	✓	8,5	0,05	

Unidades en milímetros / Units in millimeters / Unités en millimètres / Unidades em milímetros

# SERIE MONOBLOK METACRILATO /

MONOBLOCK METACRILATO SERIES /  
MONOBLOCK METACRILATO SERIES /  
SÉRIE MONOBLOCK METACRILATO /



MOD. CM3P1600-D  
COD. 42912

22,0 0,19 <p>COD: 42802 MOD: CM2P1200-S</p>	44,0 0,38 <p>COD: 42812 MOD: CM2P1200-D</p>	25,0 0,26 <p>COD: 42902 MOD: CM2P1600-S</p>	28,0 0,26 <p>COD: 42913 MOD: CM4P1600-S</p>	53,0 0,51 <p>COD: 42912 MOD: CM3P1600-D</p>
24,0 0,19 <p>COD: 42803 MOD: CM3P1200-S</p>	48,0 0,38 <p>COD: 42813 MOD: CM3P1200-D</p>	26,0 0,26 <p>COD: 42904 MOD: CM3P1600-S</p>	50,0 0,51 <p>COD: 42903 MOD: CM2P1600-D</p>	55,0 0,51 <p>COD: 42914 MOD: CM4P1600-D</p>

# SERIE SUPERMERCADO HORIZONTAL /

SUPERMERCADO HORIZONTAL SERIES /  
SÉRIE SUPERMERCADO HORIZONTAL /  
SÉRIE SUPERMERCADO HORIZONTAL /

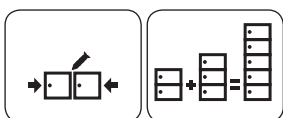

COD.	MOD.	↑	↔	↗	□	🔑	👤	kg	M <sup>3</sup>
95200	TSH3P	410	870	400	3	✓	–	19,0	0,14
95202	CSH3P	410	870	400	3	–	✓	21,0	0,14
95100	TSH2P	410	580	400	2	✓	–	13,0	0,09
95102	CSH2P	410	580	400	2	–	✓	12,0	0,09

# SERIE MAXI /

MAXI SERIES / SÉRIE MAXI / SÉRIE MAXI /

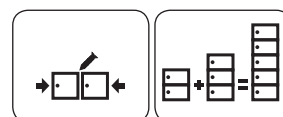

COD.	MOD.	↑	↔	↗	□	🔑	👤	kg	M <sup>3</sup>
97305	TMAXI1P	1170	300	500	1	✓	–	12,0	0,18
97300	CMAXI1P	1170	300	500	1	–	✓	13,0	0,18
95600	TSV2PMAXI	800	300	500	2	✓	–	14,0	0,12
95602	CSV2PMAXI	800	300	500	2	–	✓	15,0	0,12

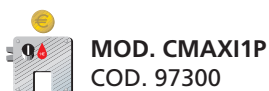
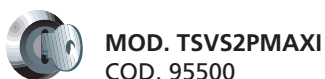



# SERIE MARCO AMARRE /

MARCO AMARRE SERIES /  
 SÉRIE MARCO AMARRE /  
 SÉRIE MARCO AMARRE /



**MOD. MA4P1500**  
**COD. 90422**

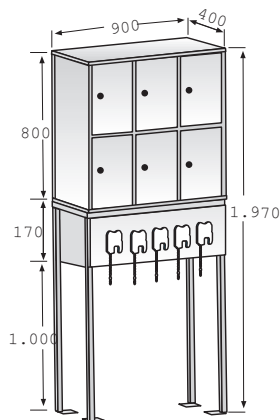

**3 CSV2P + 1 MA900**

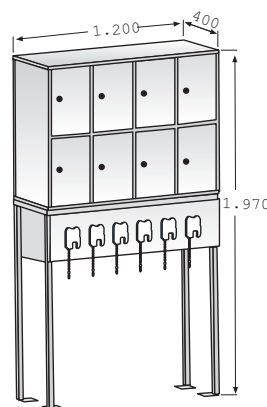

**4 CSVS2P + 1 MA1200**

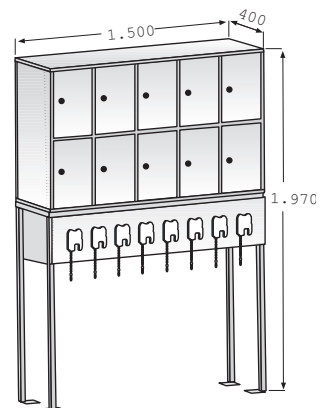

**5 CSVS2P + 1 MA1500**

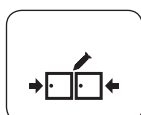

COD.	MOD.	↑↓	↔	↗↘	🔒	📊	M <sup>3</sup>
90222	MA4P900	1170	900	400	5	18,5	0,08
90322	MA4P1200	1170	1200	400	6	21,0	0,09
90422	MA4P1500	1170	1500	400	8	23,5	0,10

# SERIE GOLF / GOLF SERIES / SÉRIE GOLF / SÉRIE GOLF /



 **MOD. CGOLF1P**  
COD. 99500



 **MOD. TGOLF1P**  
COD. 99600

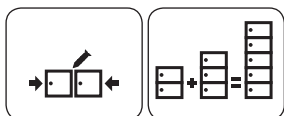

COD.	MOD.	↑	↔	↗	🔒	🗑️	🏋️	M <sup>3</sup>
99500	CGOLF1P	1240	500	600	–	✓	22,0	0,37
99600	TGOLF1P	1240	500	600	✓	–	21,0	0,37

# SERIE MALETAS / SUITCASE SERIES / SÉRIE VALISES / SÉRIE MALAS /



 **MOD. CMAL1P**  
COD. 97500



OPCIÓN: FENÓLICO  
OPTION: HPL  
OPTION: STRATIFIE COMPACT  
OPÇÃO: RESINAS FENÓLICAS

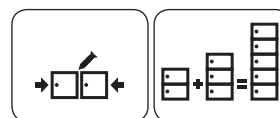

COD.	MOD.	↑	↔	↗	🔒	🗑️	🏋️	M <sup>3</sup>
97500	CMAL1P	900	500	700	–	✓	39,0	0,31

## CARACTERÍSTICAS / CHARACTERISTICS / CARACTERISTIQUES / CARACTERISTICAS



No es recomendable para espacios húmedos.  
Not recommended for wet spaces.  
Pas recommandé pour les environnements humides.  
Nao é recomendável para lugares com humidade.

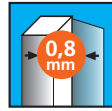

Sin montaje.  
Without assembly.  
Pas de montage.  
Sem montagem.



Microtexturado.  
Microtextured.  
Microtexturé.  
Microtexturado.



Color standard: Gris RAL 7035.  
Standard colour: Grey RAL 7035.  
Couleur standard: gris ral 7035.  
Cor standard: cinza ral 7035.



Metal.  
Metal.  
Metal.  
Metal.



Pintado en Epoxi.  
Painted in Epoxy.  
Peinture en epoxi.  
Pintura em epoxi.



Gran resistencia.  
Great resistance.  
Très résistant.  
Muito resistente.

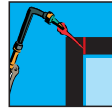

Estructura soldada.  
Welded structure.  
Structure soudée.  
Estrutura soldada.

## OPCIONES / OPTIONS / OPTIONS / OPÇÕES

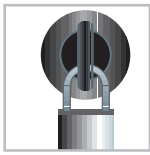

Pomo en poliamida  
(candado opcional)  
Padlockable Polyamide Lock  
(optional padlock)  
Poignée cadenassable en  
polyamide (cadenas en option)  
Fechadura de cadeado em  
poliamida

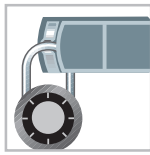

Pomo metálico (candado  
combinación opcional)  
Padlockable Metallic Lock  
(optional combination padlock)  
Poignée métallique (cadenas à  
combinaison en option)  
Fechadura de cadeado em  
metal



Cerradura de combinación y  
llave de emergencia  
Lock of 4 manual digits with  
emergency key  
Serrure à combinaison et clef  
de émergence  
Fechadura de combinação e  
chave de emergência



Monedero (moneda retornable).  
Coin-operated Lock (coin-return).  
Monnayeur (monnaie réversible).  
Moedeiro (moeda retornável).



Monedero + cajetin depósito.  
Coin-operated Lock + Coin  
Collect Box (cash box, non  
coin-return).  
Monnayeur + tirelire (monnaie  
non réversible).  
Moedeiro + caixinha para as  
moedas.

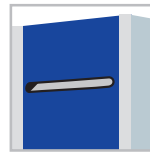

Ranura buzón. Puertas sin  
ventilación  
Mailbox Slot. Doors without  
vent system  
Rainure pour boîte à lettres.  
Portes sans volet d'aération  
Obertura para cartas. Portas  
sem ventilação



Cerradura electrónica de  
combinación de 4 dígitos.  
Electronic lock combination  
of 4 digits.  
Serrure électronique à  
combinaison de 4 chiffres.  
Fechadura electrónica,  
combinacao de 4 dígitos.

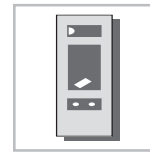

Cerradura de proximidad  
Lock of proximity  
Serrure de proximité  
Fechadura de proximidade



Pulsera de nylon  
Bracelet of nylon  
Bracelet en nylon  
Pulseira de náilon



Pulsera elástica  
Elastic Bracelet  
Bracelet élastique  
Pulseira elástica



Placa de numeración incluida.  
Numeration plate included.  
Plaque numérique inclus.  
Placa de numeração inclusa.

## COLORES OPCIONALES / OPTIONAL COLOURS / COULEURS EN OPTION / CORES OPCIONAIS



RAL 9010



RAL 6029



RAL 1021



RAL 1017



RAL 3000



RAL 3005



RAL 6034



RAL 5015



RAL 5023



RAL 2004



RAL 7016



RAL 7036



RAL 9006



RAL 9005



Empresa Homologada por la  
Dirección General del Patrimonio del Estado

---

[mobiliar@mobiliar.es](mailto:mobiliar@mobiliar.es)  
[www.mobiliar.es](http://www.mobiliar.es)  
902 365 064



#### **CENTRAL**

C/ La Fragua, 5 • Edificio Mobiliar • Pl. "Los Rosales"  
Tel.: 916 656 230 • Fax: 916 641 506  
28933 Móstoles (Madrid)

#### **DELEGACIÓN**

C/ Pere el Ceremonios, 3 • Nave 2 • Pl. "Masía de Espí"  
Tel.: 961 534 064 • Fax: 961 537 790  
46930 Quart de Poblet (Valencia)

#### **FÁBRICA**

Avda. de las Retamas, s/n • Pl. "Monte Boyal"  
Tel.: 918 171 744 • Fax: 918 170 952  
45950 Casarrubios del Monte (Toledo)