

SERIE LOOPY



ASESORAMIENTO
PERSONALIZADO

INGENIERÍA
Y PROYECTOS

SOLUCIONES
LLAVE EN MANO

EQUIPAMIENTO
INTEGRAL

ATENCIÓN
AL CLIENTE



Empresa Homologada por la
Dirección General del Patrimonio del Estado

mobiliar@mobiliar.es
www.mobiliar.es
902 365 064



Lo spazio riunione per esprimere idee con stile ed efficacia. Finiture dei piani e strutture metalliche per aggiungere un tocco di classe all'immagine aziendale.

The meeting area for expressing ideas is recognised by style and effectiveness. Special finishes for the tops and metallic structures to add a touch of class to the company image.

L'espace de réunion exprime les idées avec style et efficacité. Les finitions des plateaux et des structures métalliques ajoutent une touche de classe à l'image de l'entreprise.

Der Bereich für die Zusammenkunft, um Ideen mit Stil und Wirkungskraft vorzubringen. Die Finish-Ausführungen der Platten und die Metallstrukturen bereichern das Image des Unternehmens um einen Hauch von Klasse.

De vergaderruimte om met stijl en werkzaamheid ideeën uit te drukken. Afwerking van de vlakken en metalen structuren om een beetje klasse aan het beeld van de firma toe te voegen.

El espacio de reunión para expresar ideas con estilo y efectividad. Acabados de los planos y estructuras metálicas para añadir un toque de estilo a la imagen de la empresa.





Loopy propone un minimalismo sempre elegante e mai freddo: i materiali impiegati quali il legno, il vetro, il metallo, sono fondamentali per esprimere leggerezza ma solidità, rigore ed efficienza.

Loopy proposes a elegant and warm minimalist effect: the materials used such as wood, glass and steel are vital to express a light yet solid effect, rigour and efficiency.

Loopy propose un minimalisme toujours élégant et jamais froid: les matériaux employés, tels que le bois, le verre, le métal, sont fondamentaux pour exprimer la légèreté en même temps que la solidité, la rigueur et l'efficacité.

Loopy bietet einen stets eleganten und niemals kalten Minimalismus: die eingesetzten Materialien wie Holz, Glas, Metall stellen wesentliche Elemente der Leichtigkeit und gleichzeitiger Solidität, der Strenge verbunden mit Leistungsfähigkeit dar.

Het voorstel van Loopy is een elegant minimalisme: de gebruikte materialen, waaronder hout, glas en metaal, zijn van fundamenteel belang om de combinatie van solide kwaliteit met licht gewicht, van gedegenheid met efficiëntie tot uitdrukking te brengen.

Loopy propone un minimalismo siempre elegante y nunca frío: los materiales utilizados como la madera, el vidrio, el metal, son fundamentales para expresar ligereza y solidez, rigor y eficiencia.



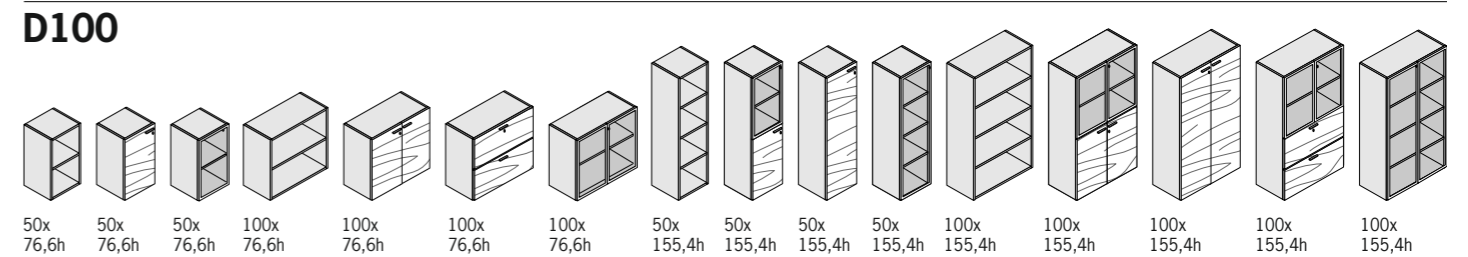
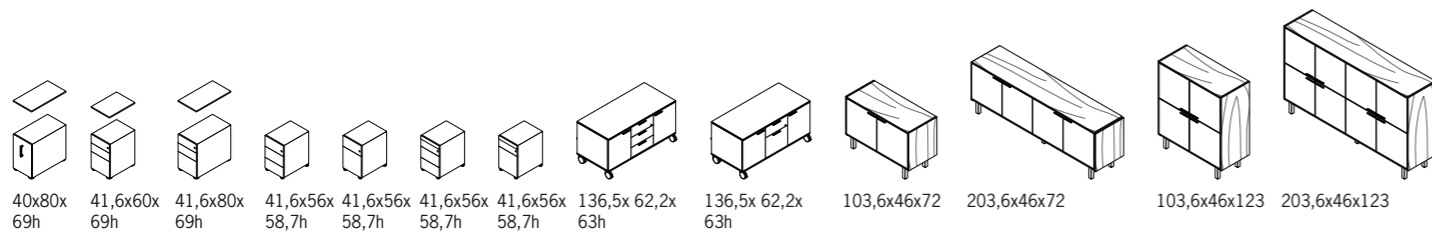
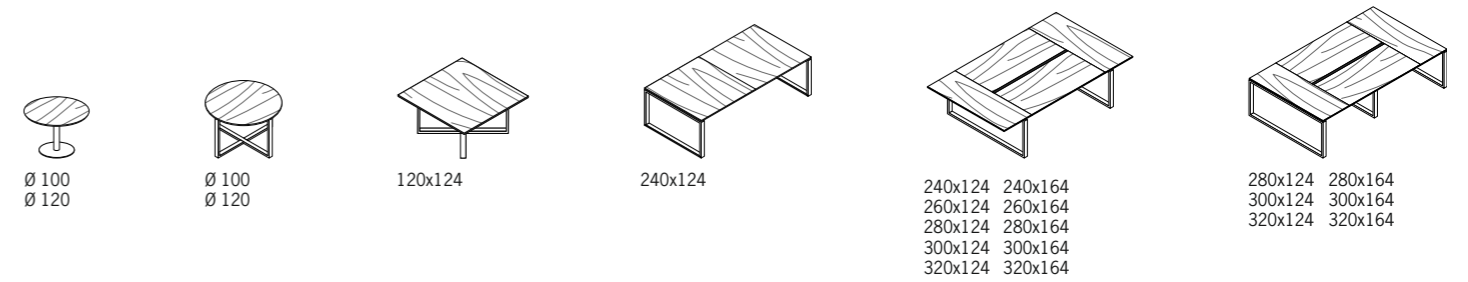
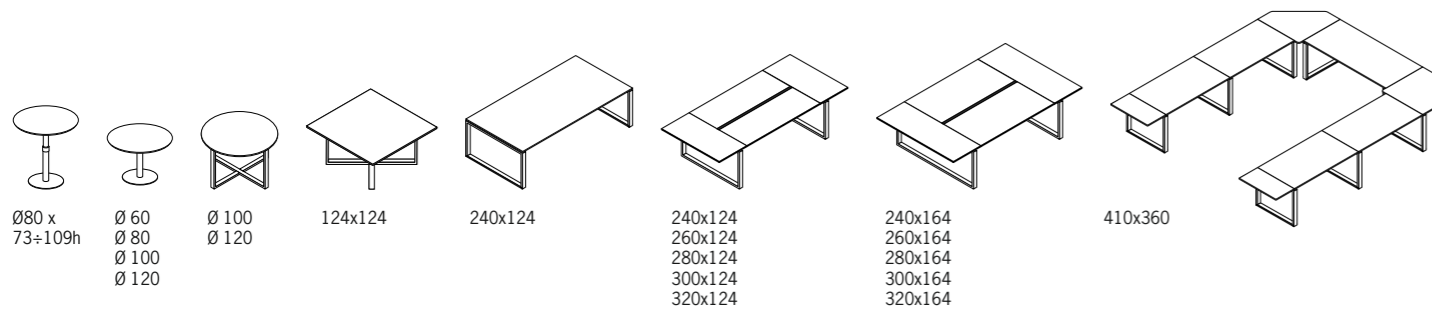
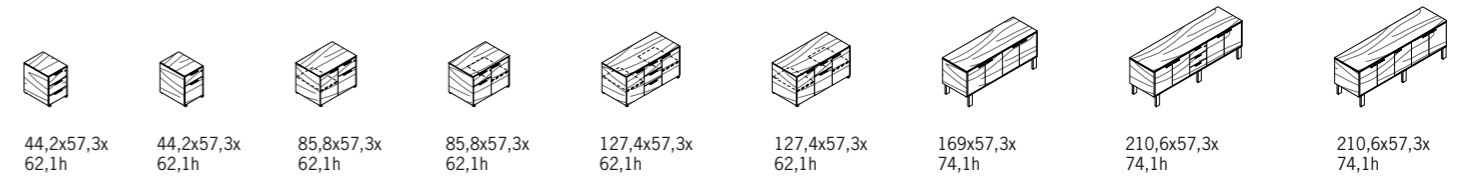
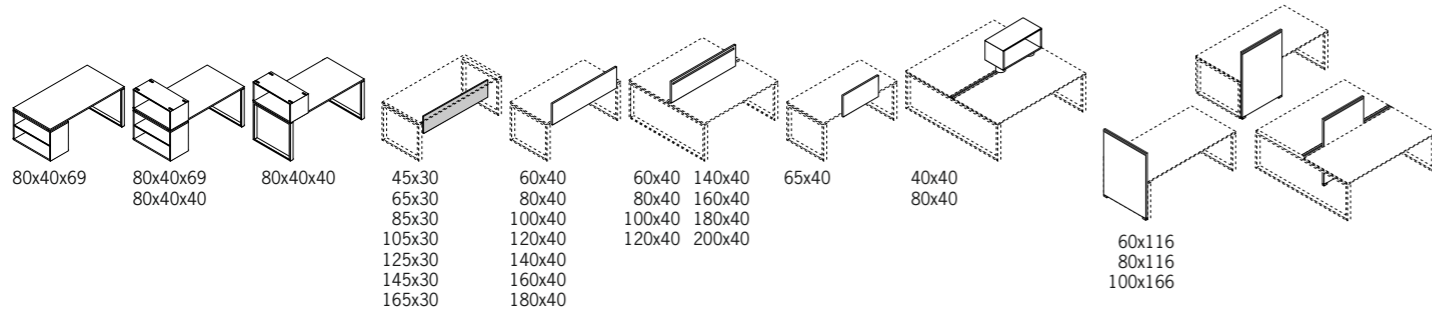
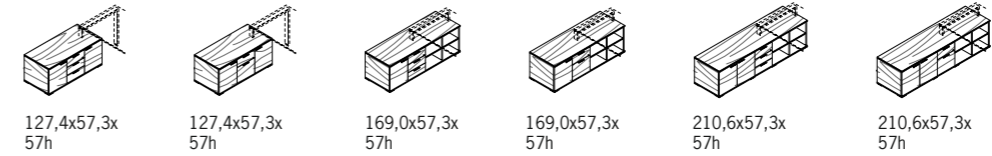
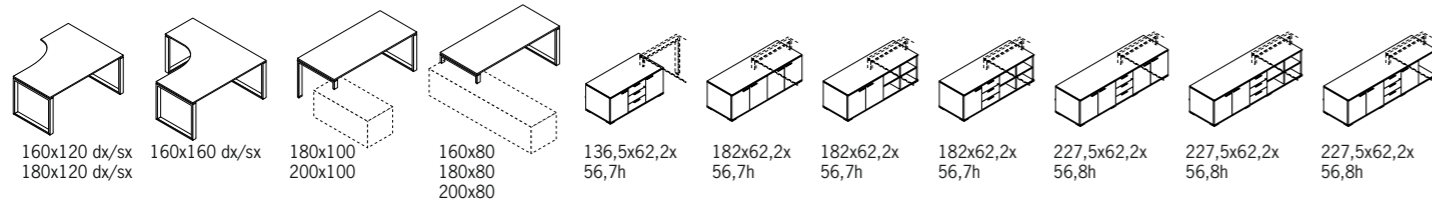
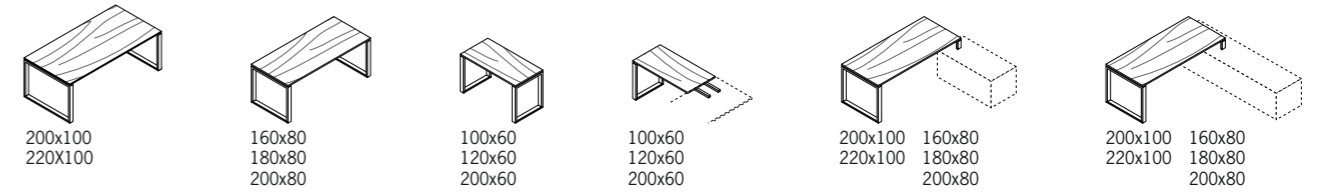
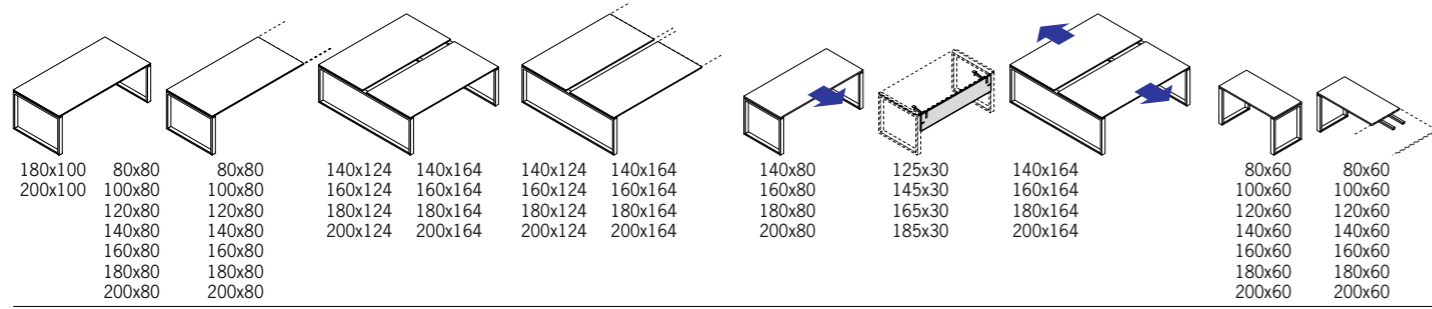

A100

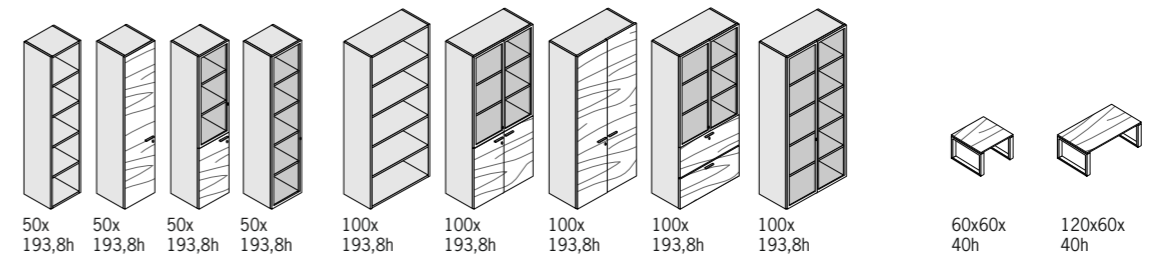
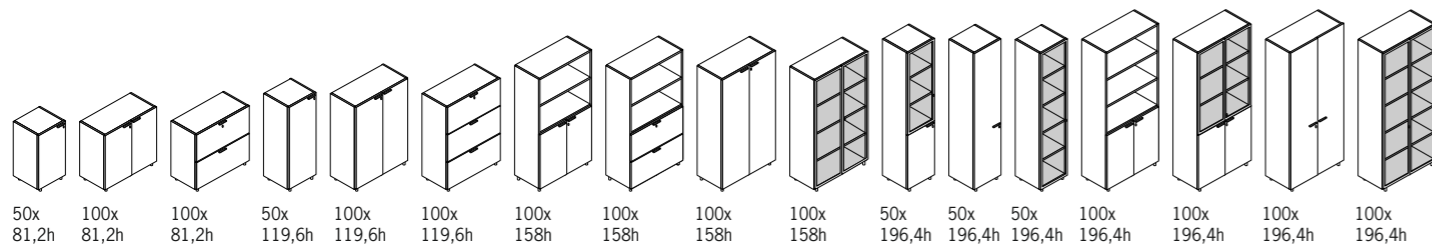

WP Legno Wengè - Wengè wood
Bois wengè - Wengeholz
Wengè hout - Madera wengè

NP Legno Noce Americano
American walnut wood
Bois Noyer Americano
Americano nußbaumholz
Notenhout Americano
Madera Nogal Americano

NC Noce Canaletto
Canaletto Walnut
Canaletto Noyer
Canaletto Nußbaum
Notenhout Canaletto
Nogal Canaletto

WE Wengè - Wengè - Wengè
Wengè - Wengè - Wengè

RN Rovere Naturale - Oak
Eiche - Eikenhout
Rouvre - Roble Natural

AC Acero - Maple
Erable - Ahorndekor
Esdoornout - Arce

GP Grigio Perla - Pearl Grey
Gris Perle - Perlgrau
Parel Grijs - Gris Perla

BL Bianco - White - Blanc
Weiß - Wit - Blanco

MO Tortora - Tortora - Tortora
Tortora - Tortora - Tortora

MH Nebbia - Nebbia - Nebbia
Nebbia - Nebbia - Nebbia

HK Laminato Nero
Black Laminated
Lamifié Noir
Lamelliert Schwarz
Galamineerd Zwart
Laminado Negro

HW Laminato Bianco
White Laminated
Lamifié Blanc
Lamelliert Weiß
Galamineerd Wit
Laminado Blanco

**VETRO - GLASS
VERRE - GLAS
GLAS - VIDRIO**

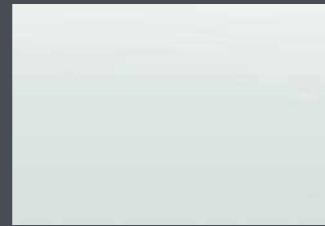

CT Vetrol temperato satinato
Tempered glass satin
Verre trempé satiné
Temperiertes Glas mattier
Gehard glas gesatineerd
Vidrio templado satinado

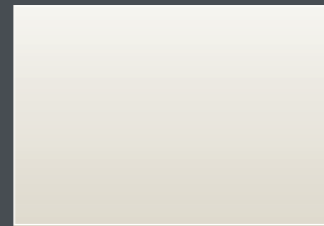

CH Vetrol temperato Nebbia
Mist tempered glass
Verre trempé Brouillard
Nebelgrau Temperiertes Glas
Gehard glas Mist
Vidrio templado Niebla

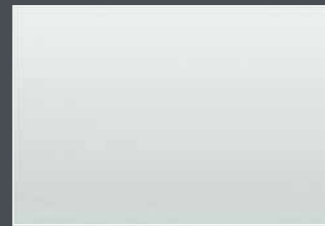

CS Vetrol Bisatinato
Glass frosted on both sides
Verre satiné sur les deux faces
Beidseitig satiniertes Glas
Tweezijdig gesatineerd glas
Vidrio bisatinado



CO Vetrol temperato Tortora
Turtledove tempered glass
Verre trempé Tourterelle
Taubenblau Temperiertes Glas
Gehard glas Tortora
Vidrio templado Tortola



CN Vetrol temperato nero
Black tempered glass
Noir verre trempé
Temperiertes Glas schwarz
Gehard glas zwart
Vidrio templado negro



CU Vetrol temperato Titanio
Titanium tempered glass
Verre trempé Titanium
Titan Temperiertes Glas
Gehard glas Titanium
Vidrio templado Titanio

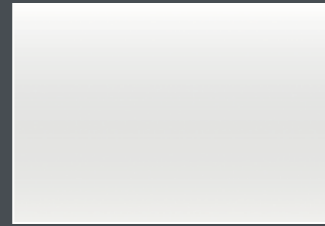

CB Vetrol temperato bianco
White tempered glass satin
Verre trempé blanc
Temperiertes Glas weiß
Gehard glas wit
Vidrio templado blanco

**VETRO OPACO - MAT GLASS
MAT VERRE - MAT GLAS
MAT GLAS - VIDRIO MATE**

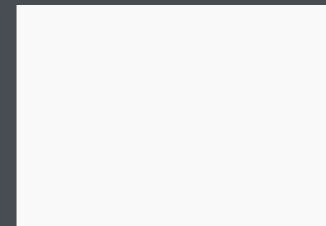

SB Vetrol temperato opaco bianco
Mat White tempered glass satin
Verre trempé opaque blanc
Temp. mattier Glas weiß
Gehard glas wit mat
Vidrio templado mate blanco

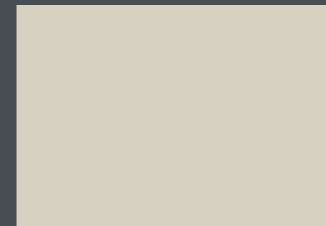

CH Vetrol temperato opaco Nebbia
Mat Mist tempered glass
Verre trempé opaque Brouillard
Nebelgrau Temp. mattier Glas
Gehard glas Mist mat
Vidrio templado mate Niebla

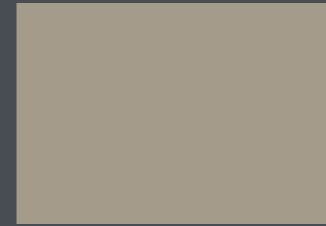

SO Vetrol temperato opaco Tortora
Mat Turtledove tempered glass
Verre trempé opaque Tourterelle
Taubenblau Temp. mattier Glas
Gehard glas Tortora mat
Vidrio templado mate Tortola

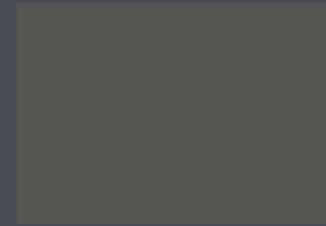

SU Vetrol temperato opaco Titanio
Mat Titanium tempered glass
Verre trempé opaque Titanium
Titan Temp. mattier Glas
Gehard glas Titanium mat
Vidrio templado mate Titanio

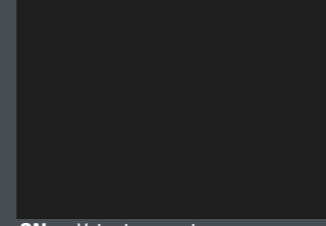

SN Vetrol temperato opaco nero
Mat Black tempered glass
Noir verre trempé opaque
Temp. mattier Glas schwarz
Gehard glas zwart mat
Vidrio templado mate negro

**LACCATI - LACQUERED
LAQUÈS - LACKIERTES
GELAKT - LAQUEADO**

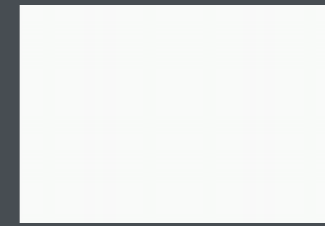

LB Laccato Bianco
White Laquered
Laqué Blanc
Weiß Lackiert
Wit Gelakt
Laqueado Blanco

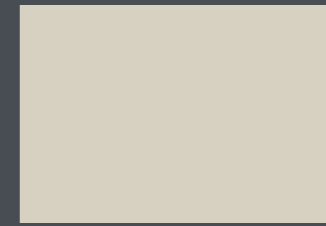

L3 Laccato Nebbia
Fog Lacquered
Laqué Brouillard
Nebelgrau Lackiert
Mist Lak
Lacado Niebla

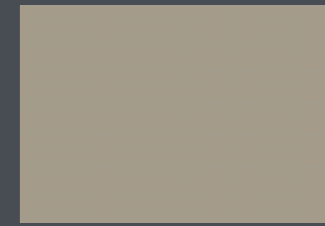

L2 Laccato Tortora
Turtledove Lacquered
Laqué Tourterelle
Taubenblau Lackiert
Tortora Lak
Lacado Tortola

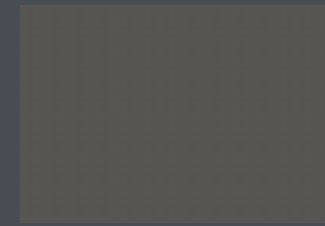

L4 Laccato Titanio
Titanium Lacquered
Laqué Titanium
Titan Lackiert
Titanium Lak
Lacado Titanio

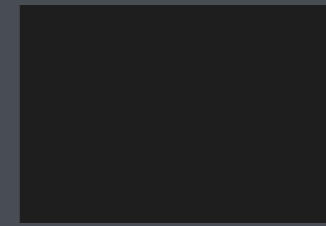

LN Laccato Nero
Black Laquered
Laqué Noir
Schwarzlackiert
Zwart Gelakt
Laqueado Negro

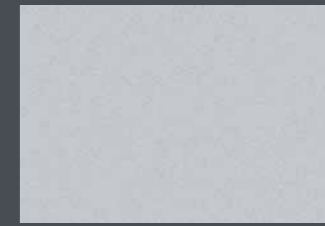

LA Laccato Alluminio
Aluminium Laquered
Laqué Aluminium
Aluminium Lackiert
Aluminium Gelakt
Laqueado Aluminio



LQ Laccato Tangerine
Tangerine Lacquered
Laqué Mandarine
Tangerine Lackiert
Tangerine Lak
Lacado Tangerine

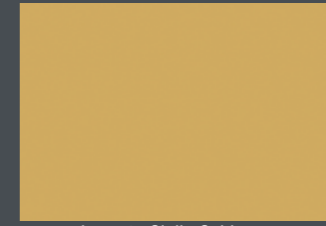

LJ Laccato Giallo Gold
Yellow Gold Lacquered
Laqué Jaune Or
Gold Lackiert
Goudgeel Lak
Lacado Amarillo Gold

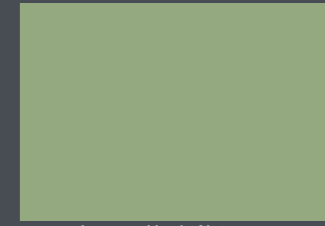

LF Laccato Verde Natura
Gras Green Lacquered
Laqué Vert Nature
Grasgrün Lackiert
Grasgroen Lak
Lacado Verde Naturaleza

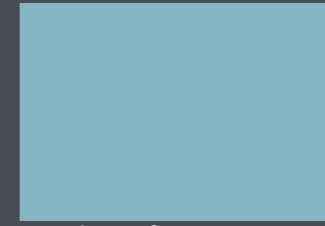

L5 Laccato Oceano
Ocean Lacquered
Laqué Ocean
Meer blau Lackiert
Oceaan Lak
Lacado Oceano

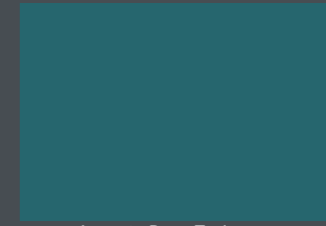

LE Laccato Deep Teal
Deep Teal Lacquered
Laqué Bleu Canard
Deep Teal Lackiert
Deep Teal Lak
Lacado Deep Teal



LR Laccato Rosso Bordeaux
Bordeaux Laquered
Laqué Bordeaux
Bordeaux Lackiert
Bordeau Gelakt
Laqueado Burdeos

**STRUTTURA METALLICA
METAL STRUCTURE
STRUCTURE MÉTALLIQUE
METALLGESTELL
METALEN STRUCTUUR
ESTRUCTURA METÁLICA**



AF Verniciato epox alluminio - Aluminium epoxy painted
Peint epoxy aluminium - Pulverbeschichtung aluminium
Geëpoxeerd aluminium - Pintado epoxidico aluminio



KR Cromo lucido - Glossy chrome
Chrome brillant - Glanzverchromt
Glanschrom - Cromo pulido



BW Verniciato epox bianco - White epoxy painted
Peint epoxy blanc - Pulverbeschichtung weiß
Geëpoxeerd wit - Pintado epoxidico blanco



TF Verniciato epox "tortora" - "turtledove" epoxy painted
Peint epoxy "tourterelle" - Pulverbeschichtung "taubenbalu"
Geëpoxeerd "tortora" - Pintado epoxidico "tortola"

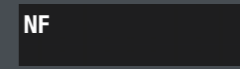

NF Verniciato epox nero - Black epoxy painted
Peint epoxy noir - Pulverbeschichtung schwarz
Geëpoxeerd zwart - Pintado epoxidico negro

Particolari tecnici, estetici, finiture o altro possono essere modificati senza preavviso.
Product details, aesthetics, finishes or other data may be subject to change without notice.



Empresa Homologada por la
Dirección General del Patrimonio del Estado

mobiliar@mobiliar.es
www.mobiliar.es
902 365 064



CENTRAL

C/ La Fragua, 5 • Edificio Mobiliar • Pl. "Los Rosales"
Tel.: 916 656 230 • Fax: 916 641 506
28933 Móstoles (Madrid)

DELEGACIÓN

C/ Pere el Ceremonios, 3 • Nave 2 • Pl. "Masía de Espí"
Tel.: 961 534 064 • Fax: 961 537 790
46930 Quart de Poblet (Valencia)

FÁBRICA

Avda. de las Retamas, s/n • Pl. "Monte Boyal"
Tel.: 918 171 744 • Fax: 918 170 952
45950 Casarrubios del Monte (Toledo)