

SERIE OTRAS MESAS



ASESORAMIENTO
PERSONALIZADO

INGENIERÍA
Y PROYECTOS

SOLUCIONES
LLAVE EN MANO

EQUIPAMIENTO
INTEGRAL

ATENCIÓN
AL CLIENTE



Empresa Homologada por la
Dirección General del Patrimonio del Estado

mobiliar@mobiliar.es
www.mobiliar.es
902 365 064



CLASSIC COLLECTION SPECIAL FEATURES

características especiales / caractéristiques spéciales / besondere merkmale

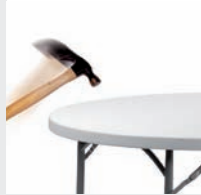

Pure polyethylene, unmixed. Quality raw material with UV protection. Shock-proof. Constructed to withstand heavy loads. Suitable for outdoor use.

Polietileno puro, sin mezclas. Materia prima de calidad y con protección UV. Flexible ante los impactos. Resistente bajo cargas pesadas. Apto para uso exterior.

Polyéthylène pur, sans mélange. Matière première de qualité, protection contre les UV. Flexibilité en cas de chocs. Résistance aux charges lourdes. Apte pour usage extérieur.

Reines Polyethylen, ohne Beimischungen. Hochwertiges Ausgangsmaterial mit UV-Schutz. Schlagzäh und von hoher Tragfähigkeit. Für den Einsatz im Außenbereich geeignet.

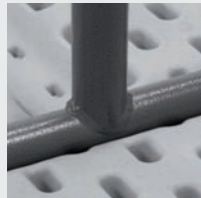

Continuous digitally welded joints. Precise and indestructible. Powder coated steel. Shock-proof and damp-proof.

Soldaduras digitales en línea. Precisas e indestructibles. Acero pintado por pulverización, resistente a los impactos y a la humedad.

Soudage numérique en ligne. Précis et indestructible. Acier peint par pulvérisation, résistant aux chocs et à l'humidité.

Digital ausgeführte Schweißnähte, präzise und unzerstörbar. Pulverlackierter Stahl, schlagfest und feuchtigkeitsbeständig.



Metal profiles of a thickness designed to withstand extreme loads.

Perfiles metálicos con grosor dimensionado para soportar cargas extremas.

Profils métalliques d'une épaisseur apte à supporter des charges extrêmes.

Metallprofile von ausreichender Dicke für extreme Belastungen.

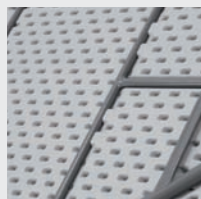

High density of vaults in the lower surface of the table top. Resistant and non-warping.

Alta densidad de bóvedas en el plano inferior del sobre. Resistente e indeformable.

Haute densité des voûtes sur le plan intérieur du plateau. Résistant et indéformable.

Zahlreiche wabenförmige Öffnungen an der Unterseite der Tischplatte. Strapazierfähig und unverformbar.



Individual polypropylene clip to hold the leg in position when folded. Solid and durable fastening device.

Clip independiente de polipropileno para albergar la pata en posición de plegado. Fijación perfecta y duradera.

Clip indépendant de polypropylène pour maintenir le pied en position pliée. Fixation parfaite et durable.

Unabhängige Klammer aus Polypropylen zur Aufnahme des Tischbeins in Klappposition. Perfekte und dauerhafte Fixierung.



Solid welded joints, nuts and bolts.

Tornillería y soldaduras sólidas.

Visserie et soudures solides.

Solide Schraub- und Schweißverbindungen.



Metal structures designed to optimise the weight/resistance ratio.

Estructuras metálicas diseñadas para optimizar la relación peso/resistencia.

Structures métalliques conçues pour un rapport poids/résistance optimal.

Speziell konstruierte Metallgestelle zur Optimierung des Verhältnisses zwischen Gewicht und Festigkeit.

XL SYSTEM

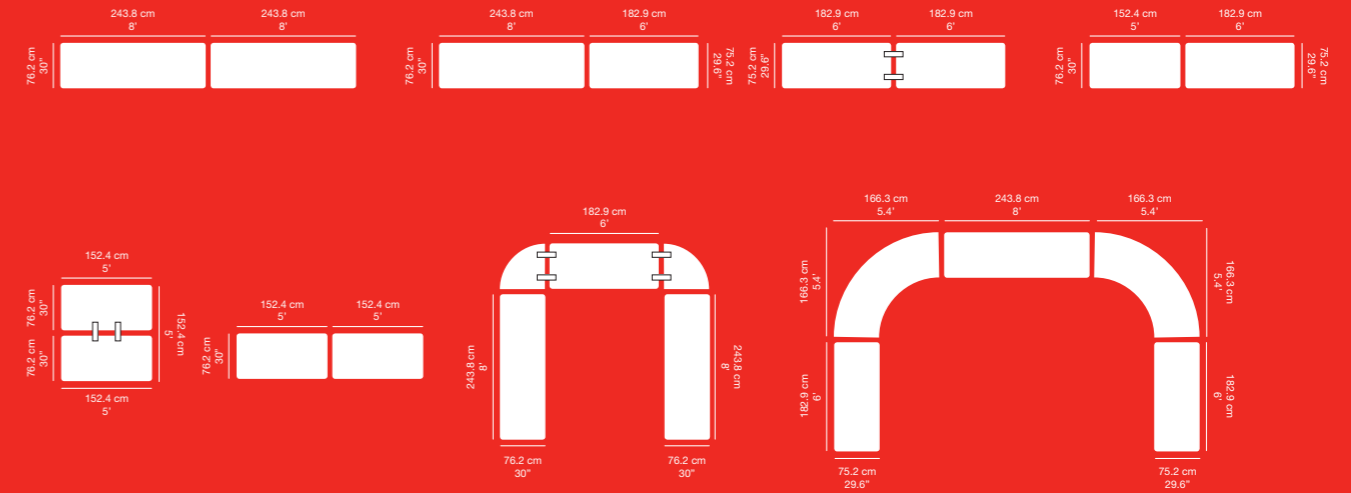

XL SYSTEM + planet180

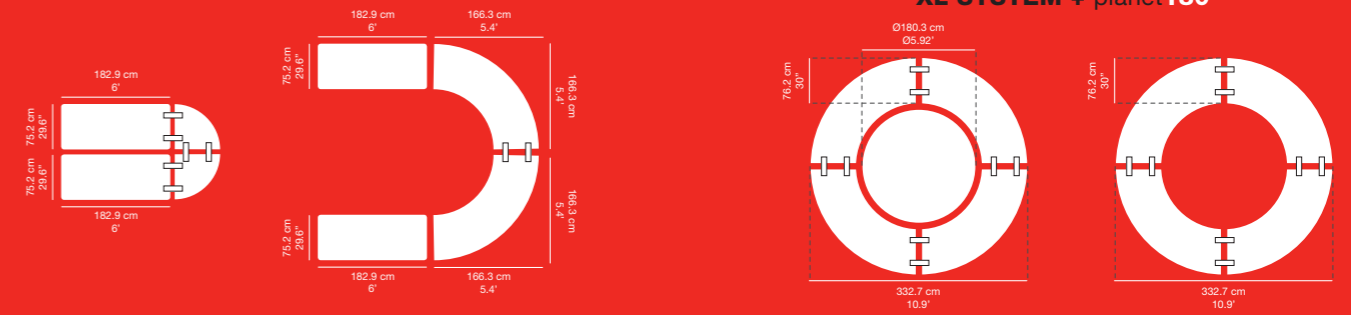

XXL SYSTEM

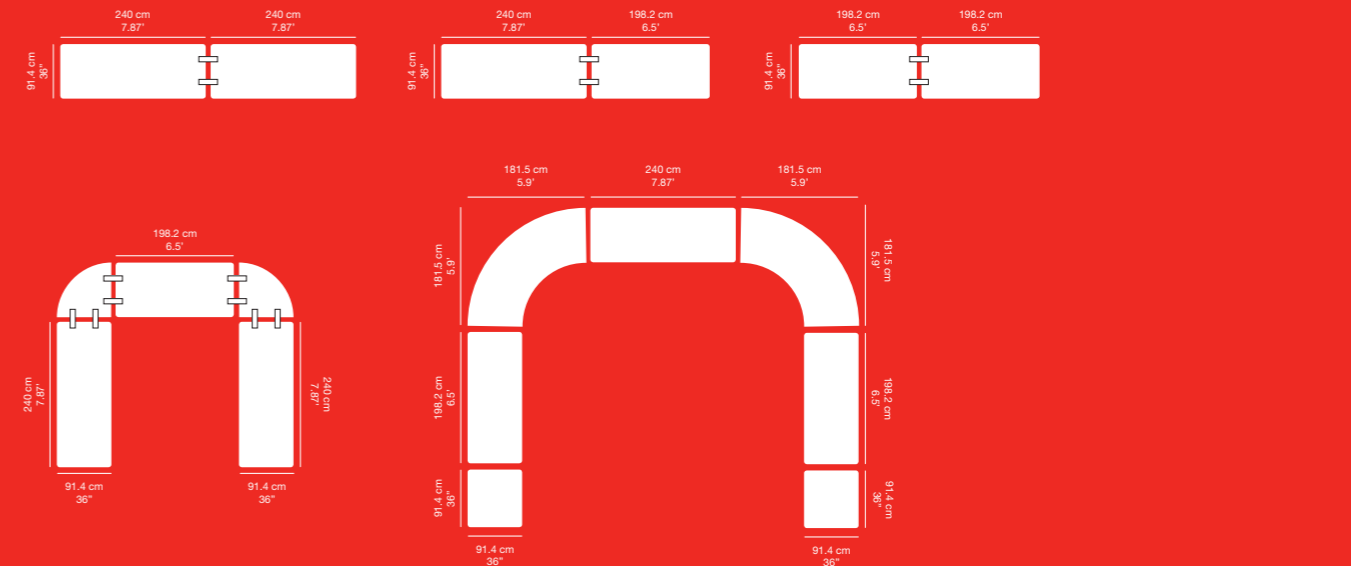

XXL SYSTEM + planet180

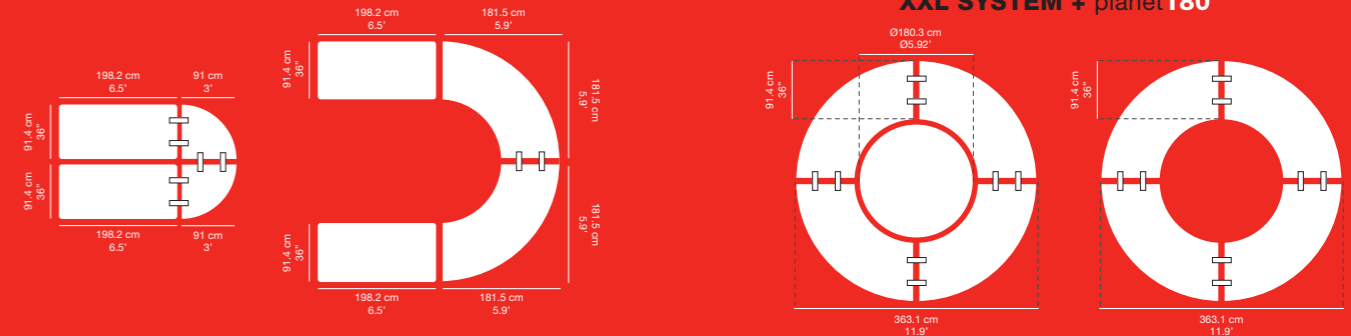

SPECIAL FEATURES

características especiales / caractéristiques spéciales / besondere merkmale



Indelible label sewn to the product which clearly indicates its name and use for rapid identification and classification, thereby avoiding confusion and time-wasting.

Etiquetas indelebles cosidas al producto que indican claramente su nombre y utilidad para una rápida identificación y clasificación, evitando desórdenes y pérdidas de tiempo.

Étiquettes indélébiles cousues aux produits indiquant clairement leur nom et leur utilité pour une identification et un tri rapides, évitant ainsi désordres et pertes de temps.

Am Produkt festgenähte, unlöschbare Etiketten mit klarer Angabe des Namens und Verwendungszwecks für eine rasche Identifikation und Sortierung, um Verwirrung und unnötigen Zeitaufwand zu vermeiden.



Crease-resistant fabrics, which are easy to wash and iron, retaining their shape and with no shrinkage.

Tejidos resistentes a las arrugas y fáciles de lavar y planchar. Mantienen su forma sin encogerse.

Tissus anti-plis, faciles à laver et à repasser, qui conservent leur forme et ne rétrécissent pas.

Pflegeleichte, faltenbeständige Stoffe, die ihre Form beim Waschen und Bügeln behalten und nicht eingehen.

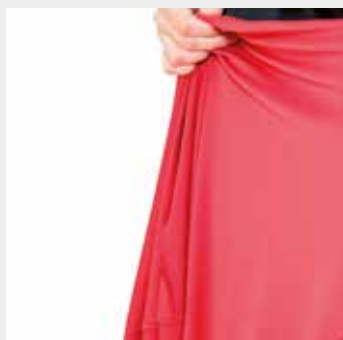

Special stitching designed to create strong seams and fray-resistant edges in order to withstand wear and tear.

Costuras especialmente confeccionadas para crear uniones fuertes que soporten bien los tirones y bordes resistentes que no se deshilachen.

Mode de fabrication spécialement mis au point pour obtenir des coutures durantes et des bords qui ne s'effilochent pas, afin de résister à l'usure naturelle.

Verschleißbeständige Spezialnähte für dauerhaft feste Säume und fransenlose Ränder.



Attractive packaging which clearly identifies its content and use, facilitating its classification, display and storage.

Embalajes atractivos que identifican claramente su contenido y utilidad, facilitando su clasificación, exposición y conservación.

Emballages attrayants qui permettent d'identifier clairement leur contenu et l'utilité des produits, facilitant ainsi leur tri, leur exposition et leur entreposage.

Attraktive Verpackungen mit klarer Angabe von Inhalt und Verwendungszweck zur einfacheren Sortierung, Ausstellung und Aufbewahrung.



thetextilecollection















The Zown Textile Collection comprises a range of standard furniture covers especially designed to fit each of Zown's classic products. A broad spectrum of styles and solid colours are available. This Textile Collection is set apart by:

- Styles fully in line with Zown's classic product range of furniture.
- Fabrics and weights which have been selected to strike the perfect balance between performance, aesthetics and durability.
- Special stitching designed to create strong seams and fray-resistant edges in order to withstand wear and tear.
- Crease-resistant fabrics, which are easy to wash and iron, retaining their shape and with no shrinkage.
- Stretch fabric containing 10% Lycra, which is elastic and returns to its original shape without any deformation.

La colección textil de Zown comprende toda una gama de fundas para muebles estándar especialmente diseñada para que se adapte a todos y cada uno de los productos de la colección Zown Classic. Disponibles en un amplio abanico de estilos y colores sólidos, los artículos de esta colección se distinguen por:

- Patrones perfectamente ajustados a la colección de muebles Zown classic.
- Las telas y sus gramajes han sido seleccionados para lograr el equilibrio perfecto entre rendimiento, estética y durabilidad.
- Costuras especialmente confeccionadas para crear uniones fuertes que soporten bien los tirones y bordes resistentes que no se deshilachen.
- Tejidos resistentes a las arrugas y fáciles de lavar y planchar. Mantienen su forma sin encogerse.
- Tejidos stretch con un 10% de lycra, les dota de elasticidad y les permite recuperar su forma original sin deformarse.



 White - Blanco Blanc - Weiß	 White - Blanco Blanc - Weiß
 Ecrú - Blanco roto Blanco roto - Blanco roto	 Ecrú - Blanco roto Blanco roto - Blanco roto
 Sand - Arena Sable - Sand	 Sand - Arena Sable - Sand
 Anthracite - Antracita Anthracite - Anthrazit	 Anthracite - Antracita Anthracite - Anthrazit
 Black - Negro Noir - Schwarz	 Black - Negro Noir - Schwarz
 Burgundy - Burdeos Bordeaux - Bordeaux	 Burgundy - Burdeos Bordeaux - Bordeaux
 Red - Rojo Rouge - Rot	 Blue - Azul Bleu - Blau

La Collection Textile Zown est constituée d'une gamme de housses de meubles standard, spécialement conçues pour s'adapter à chaque produit Zown classic. Un large choix de styles et de couleurs unies est disponible. Cette Collection Textile se distingue grâce aux éléments suivants:

- Styles en accord parfait avec la gamme de meubles Zown classic.
- Tissus et poids pensés pour obtenir l'équilibre parfait entre performance, esthétique et durabilité.
- Mode de fabrication spécialement mis au point pour obtenir des coutures durantes et des bords qui ne s'effilochent pas, afin de résister à l'usure naturelle.
- Tissus anti-plis, faciles à laver et à repasser, qui conservent leur forme et ne rétrécissent pas.
- Tissu stretch contenant 10% de lycra : élastique, il reprend sa forme d'origine sans aucune déformation.

Die Textil-Kollektion von Zown beinhaltet verschiedene Standard-Hussen, die speziell den einzelnen Zown-Classic-Produkten angepasst sind. Zur Auswahl steht eine breite Palette an Modellen und beständigen Farben. Die Textil-Kollektion besticht durch folgende Merkmale:

- Die Modelle sind vollständig auf die Zown-Classic-Möbel abgestimmt.
- Die Stoffe und Stärken zielen auf ein perfektes Gleichgewicht aus Leistung, Ästhetik und Strapazierfähigkeit.
- Verschleißbeständige Spezialnähte für dauerhaft feste Säume und fransenlose Ränder.
- Pflegeleichte, faltenbeständige Stoffe, die ihre Form beim Waschen und Bügeln behalten und nicht eingehen.
- Elastischer Stretch-Stoff mit 10% Lycra, nimmt ohne Verziehen wieder seine Ausgangsform ein.

COLOURS

colores / couleurs / farben

stretch Table, Bench and Chair Cover Colours 90% PES 10% LYCRA, 200 g/m², knitted



paramount Cover and Partial-Skirt Colours 100% PES, 200 g/m², knitted



plain Cover Colours 100% PES, 200 g/m², knitted



bridge Cover Colours 100% PES, 200 g/m², knitted



Colour of Cotton Tablecloths and Napkins



STYLES

estilos / styles / stile

Full Table, Bench and Top Cover Shapes

NEW COLOURS

stretch

90% PES 10% LYCRA,
190-200 g/m², knitted



- White - Blanco
Blanc - Weiß
- Ecu - Crudo
Écu - Cremeweiß
- Sand - Arena
Sable - Sand
- Anthracite - Antracita
Anthracite - Anthrazit
- Black - Negro
Noir - Schwarz
- Burgundy - Burdeos
Bordeaux - Bordeaux
- Red - Rojo
Rouge - Rot

paramount

100% PES,
190-200 g/m², knitted



- White - Blanco
Blanc - Weiß
- Ecu - Crudo
Écu - Cremeweiß
- Sand - Arena
Sable - Sand
- Anthracite - Antracita
Anthracite - Anthrazit
- Black - Negro
Noir - Schwarz
- Burgundy - Burdeos
Bordeaux - Bordeaux
- Blue - Azul
Bleu - Blau

plain

100% PES,
190-200 g/m², knitted



- White - Blanco
Blanc - Weiß
- Ecu - Crudo
Écu - Cremeweiß
- Sand - Arena
Sable - Sand
- Anthracite - Antracita
Anthracite - Anthrazit
- Black - Negro
Noir - Schwarz
- Burgundy - Burdeos
Bordeaux - Bordeaux
- Blue - Azul
Bleu - Blau

bridge

100% PES,
190-200 g/m², knitted



- White - Blanco
Blanc - Weiß
- Ecu - Crudo
Écu - Cremeweiß
- Sand - Arena
Sable - Sand
- Anthracite - Antracita
Anthracite - Anthrazit
- Black - Negro
Noir - Schwarz
- Burgundy - Burdeos
Bordeaux - Bordeaux
- Blue - Azul
Bleu - Blau

Partial Table Skirt

paramount

100% PES,
190-200 g/m², knitted



- White - Blanco
Blanc - Weiß
- Ecu - Crudo
Écu - Cremeweiß
- Sand - Arena
Sable - Sand
- Anthracite - Antracita
Anthracite - Anthrazit
- Black - Negro
Noir - Schwarz
- Burgundy - Burdeos
Bordeaux - Bordeaux
- Blue - Azul
Bleu - Blau

Tablecloths

tablecloths

100% CO,
230 g/m²

White - Blanco
Blanc - Weiß



Top Cover

stretch

90% PES 10% LYCRA,
200 g/m², knitted



- White - Blanco
Blanc - Weiß
- Ecu - Crudo
Écu - Cremeweiß
- Sand - Arena
Sable - Sand
- Anthracite - Antracita
Anthracite - Anthrazit
- Black - Negro
Noir - Schwarz
- Burgundy - Burdeos
Bordeaux - Bordeaux
- Red - Rojo
Rouge - Rot

Extra colours for cocktail table stretch cover and top cover

- Green - Verde
Vert - Grün
- Orange - Naranja
Orange - Orange
- Turquoise - Turquesa
Turquoise - Türkis
- Pink - Rosa
Rose - Rosa

CLASSIC COLLECTION SUMMARY
resumen / résumé / übersicht

M183

TABLE MESA TABLE TISCH
183x46xh74 cm
72"x18.1"xh29.1"



oxford180

TABLE MESA TABLE TISCH
180x50xh74.3 cm
5.9"x19.7"xh29.3"



L120

TABLE MESA TABLE TISCH
121.9x61xh74.3 cm
4'x24"xh29.2"



XXLtrolley

TROLLEY CARRO CHARIOT WAGEN
(202+46)x92xh115 cm
(79.6"+18.1")x36.2"xh45.3"



XXLmoon

TABLE MESA TABLE TISCH
181.5x181.5xh74.3 cm
5.9'x5.9'xh29.2"



XXLcorner

TABLE MESA TABLE TISCH
91.4x91.4xh74.3 cm
3'x3'xh29.2"



Ltrolley

TROLLEY CARRO CHARIOT WAGEN
131.7x62xh115 cm
51.9"x24.4"xh45.3"



XL150

TABLE MESA TABLE TISCH
152.4x76.2xh74.3 cm
5'x30"xh29.2"



XL180

TABLE MESA TABLE TISCH
182.9x75.2xh74.3 cm
6'x29.6"xh29.2"



SS60

TABLE MESA TABLE TISCH
61x61xh89 cm
24"x24"xh35"



SS120

TABLE MESA TABLE TISCH
122x61xh89 cm
48"x24"xh35"



buffettablebase

TABLE MESA TABLE TISCH
183.3x75.2xh74 cm
72.1"x29.6"xh29.1"



worktop180

TABLE MESA TABLE TISCH
182.9x76.2xh74.3/85.1/90.2/94.3 cm
6'x30"xh29.2"/33.5"/35.5"/37.1"



XL240

TABLE MESA TABLE TISCH
243.8x76.2xh74.3 cm
8'x30"xh29.2"



XLtrolley

TROLLEY CARRO CHARIOT WAGEN
(193+61)x77xh115 cm
(76"+24")x30.3"x h45.3"



planet120

TABLE MESA TABLE TISCH
Ø122xh74.3 cm
Ø4'xh29.2"



planet150

TABLE MESA TABLE TISCH
Ø152.4xh74.3 cm
Ø5'xh29.2"



planet160

TABLE MESA TABLE TISCH
Ø160xh74.3 cm
Ø63'xh29.2"



XLcorner

TABLE MESA TABLE TISCH
75.1x75.1xh74.3 cm
29.56"x29.56"xh29.2"



XLmoon

TABLE MESA TABLE TISCH
166.3x166.3xh74.3 cm
5.4'x5.4'xh29.2"



topshelf180

SHELF ESTANTE SHELF SHELF
184x30.5xh31 cm
6'x12"xh12.2"



planet180

TABLE MESA TABLE TISCH
Ø180.3xh74.3 cm
Ø5.92'xh29.2"



planettrolley

TROLLEY CARRO CHARIOT WAGEN
(132+30)x83.2xh102 cm
(52"+11.8")x32.7"xh40.2"



cocktail80

TABLE MESA TABLE TISCH
Ø81.3xh110 cm
Ø32"xh43.3"



XXL90

TABLE MESA TABLE TISCH
91.4x91.4xh74.3 cm
36"x36"xh29.2"



XXL200

TABLE MESA TABLE TISCH
198.2x91.4xh74.3 cm
6.5'x36"xh29.2"



XXL240

TABLE MESA TABLE TISCH
240x91.4xh74.3 cm
8'x36"xh29.2"



praxis80

TABLE MESA TABLE TISCH
Ø81.3xh74.3 cm
Ø32"xh29.2"



cocktailtrolley

TROLLEY CARRO CHARIOT WAGEN
121x89xh101 cm
47.6"x35"xh39.6"



snacktable

TABLE MESA TABLE TISCH
Ø70xh110 cm
Ø27.6"xh43.3"



sharptable

TABLE MESA TABLE TISCH

182.9x76.2xh74.3 cm
6'x30"xh29.2"



sharpbench180

BENCH BANCO BANC BANK

184x30.5xh44.5 cm
6'x12"xh17.5"

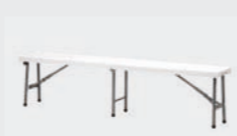

sharpbench240

BENCH BANCO BANC BANK

244.5x29.4xh44.2 cm
96.26"x11.5"xh17.4"



munich70

TABLE MESA TABLE TISCH

220x67xh77 cm
86.6"x26.4"xh30.3"



munichbench

BENCH BANCO BANC BANK

220x30xh48 cm
86.6"x11.8"xh18.9"



x-uptable

TABLE MESA TABLE TISCH

76.2x49.5xh34/46/56/61/66/71 cm
30"x19.5"xh13.4"/18.2"/22"/24"/26"/28"



ottochair

CHAIR SILLA CHAISE STUHL

47x54xh84.8 cm
18.5"x21.26"xh33.38"



ottotrolley

TROLLEY CARRO CHARIOT WAGEN

110x47.7xh190 cm
43.3"x18.8"xh74.8"



displayrack

DISPLAY RACK EXPOSITOR SUPPORT
D'EXPOSITION AUSSTELLUNGSTÄNDER

64.1x61xh71.1 cm
25.2"x24"xh28"



oktober175

BENCH BANCO BANC BANK

175.3x29.2xh46.4 cm
69"x11.5"xh18.3"



normantrolley

TROLLEY CARRO CHARIOT WAGEN

110x48xh190 cm
43.3"x18.9"xh74.8"



ZOWN

the **classic** collection

THE TESTER video!



We have performed a shock and load test comparing Zown folding tables with asian competitor's tables. **Watch the tester results!**

Hemos realizado pruebas de resistencia a impactos y de capacidad de carga comparando las mesas plegables de Zown con las mesas de los competidores asiáticos. **¡Mira los resultados de las pruebas!**

Nous avons effectué des essais de résistance aux chocs et aux charges en comparant les tables pliables de Zown à des tables fabriquées par des concurrents asiatiques. **Regardez les résultats!**

Wir haben die Klappische von Zown in einem Stoß- und Lasttest mit Tischen asiatischer Mitbewerber verglichen. **Werfen Sie einen Blick auf die Testergebnisse!**

The ZOWN CLASSIC Collection features lightweight folding furniture for professional use at banquets and events, and in the hotel and catering industry. **Proven reliability.** Lightweight, shockproof, robust furniture with a weight-bearing capacity. Hard-wearing, **competitive** and low maintenance. **The widest variety of compatible models** of different sizes. Easy to assemble and disassemble, to transport and to store (saving on space). Hygienic and easy to clean. Resistant to moisture and UV rays. Suitable for indoor and outdoor use.

Colección ZOWN CLASSIC de mobiliario ligero plegable para uso profesional en banquetes, eventos, catering y hoteles. **Solvencia contrastada.** Mobiliario ligero y resistente a los impactos, estable y adecuado para soportar peso. Duradero, **competitivo** y de bajo mantenimiento. **La más amplia variedad de modelos** compatibles de diferentes dimensiones, Fácil de montar, desmontar, transportar y ser almacenado economizando espacio. Higiénico y fácil de limpiar. Resistente a la humedad y rayos UV. Apto para uso interior y exterior.

Collection ZOWN CLASSIC de mobilier léger et pliable pour usage professionnel lors de banquets, événements, buffets et en hôtel. **Fiabilité vérifiée.** Mobilier léger et résistant aux impacts, stable et capable de supporter un poids. Durable, **compétitif** et nécessitant peu d'entretien. **Large choix de modèles compatibles** de différentes dimensions. Facile à monter, à démonter, à transporter et à stocker avec gain de place. Hygiénique et facile à nettoyer. Résistant à l'humidité et aux rayons UV. Apte pour un usage intérieur et extérieur.

Die Kollektion ZOWN CLASSIC besteht aus leichten Klappmöbeln für den gewerblichen Einsatz bei Festessen, Veranstaltungen sowie im Catering- und Hotel-Bereich. **Im Einsatz bewährt.** Leichtes, schlagfestes, stabiles und belastbares Mobiliar. Langlebig, **preisgünstig** und pflegeleicht. Verfügbar in einer **breiten Produktpalette** und in unterschiedlichen Größen. Leicht auf- und abzubauen und zu transportieren. Platzsparend in der Lagerung. Hygienisch und leicht zu reinigen. Feuchtigkeits- und UV-beständig. Sowohl für den Innen- als auch für den Außenbereich geeignet.

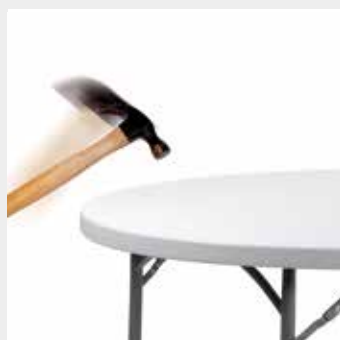

Pure polyethylene, unmixed. Quality raw material with UV protection. Shock-proof. Constructed to withstand heavy loads. Suitable for outdoor use.

Polietileno puro, sin mezclas. Materia prima de calidad y con protección UV. Flexible ante los impactos. Resistente bajo cargas pesadas. Apto para uso exterior.

Polyéthylène pur, sans mélange. Matière première de qualité, protection contre les UV. Flexibilité en cas de chocs. Résistance aux charges lourdes. Apte pour usage extérieur.

Reines Polyethylen, ohne Beimischungen. Hochwertiges Ausgangsmaterial mit UV-Schutz. Schlagzäh und von hoher Tragfähigkeit. Für den Einsatz im Außenbereich geeignet.

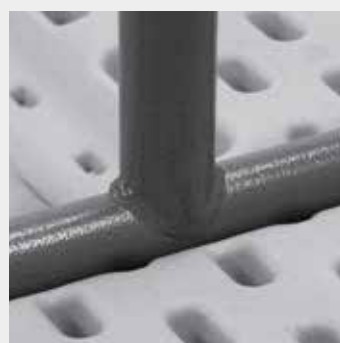

Continuous digitally welded joints. Precise and indestructible. Powder coated steel. Shock-proof and damp-proof.

Soldaduras digitales en línea. Precisas e indestructibles. Acero pintado por pulverización, resistente a los impactos y a la humedad.

Soudage numérique en ligne. Précis et indestructible. Acier peint par pulvérisation, résistant aux chocs et à l'humidité.

Digital ausgeführte Schweißnähte, präzise und unzerstörbar. Pulverlackierter Stahl, schlagfest und feuchtigkeitsbeständig.



Metal profiles of a thickness designed to withstand extreme loads.

Perfiles metálicos con grosor dimensionado para soportar cargas extremas.

Profils métalliques d'une épaisseur apte à supporter des charges extrêmes.

Metallprofile von ausreichender Dicke für extreme Belastungen.

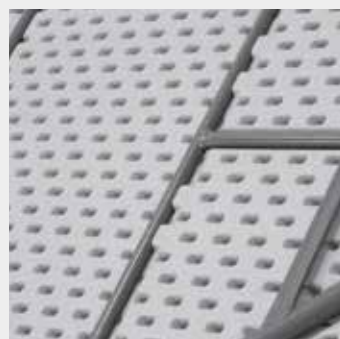

High density of vaults in the lower surface of the table top. Resistant and non-warping.

Alta densidad de bóvedas en el plano inferior del sobre. Resistente e indeformable.

Haute densité des voûtes sur le plan intérieur du plateau. Résistant et indéformable.

Zahlreiche wabenförmige Öffnungen an der Unterseite der Tischplatte. Strapazierfähig und unverformbar.

Individual polypropylene clip to hold the leg in position when folded. Solid and durable fastening device.

Clip independiente de polipropileno para albergar la pata en posición de plegado. Fijación perfecta y duradera.

Clip indépendant de polypropylène pour maintenir le pied en position pliée. Fixation parfaite et durable.

Unabhängige Klammer aus Polypropylen zur Aufnahme des Tischbeins in Klappposition. Perfekte und dauerhafte Fixierung.



Solid welded joints, nuts and bolts.

Tornillería y soldaduras sólidas.

Visserie et soudures solides.

Solide Schraub- und Schweißverbindungen.



Metal structures designed to optimise the weight/resistance ratio. The recommended maximum weight that appears on each page of the product refers to "evenly distributed" weight on the surface of the product. For the recommended maximum "concentrated" weight, please contact our sales department.

Estructuras metálicas diseñadas para optimizar la relación peso/resistencia. El peso máximo recomendado que figura en cada página de producto se refiere al peso "uniformemente repartido" en la superficie del artículo. Para conocer el peso "concentrado" máximo recomendado, consultar a nuestro departamento comercial.

Structures métalliques conçues pour un rapport poids/résistance optimal. Le poids maximum recommandé qui figure sur chaque page de produit se réfère au poids «réparti uniformément» sur la surface de l'article. Pour connaître le poids «concentré» maximum recommandé, consulter notre département commercial.

Speziell konstruierte Metallgestelle zur Optimierung des Verhältnisses zwischen Gewicht und Festigkeit. Das auf den einzelnen Produktseiten angegebene Maximalgewicht bezieht sich auf ein gleichmäßig auf der Oberfläche des Artikels verteiltes Gewicht. Auskünfte über das empfohlene maximale Punktgewicht erhalten Sie von unserer Verkaufsabteilung.



Limited
10-year
warranty

Limited
5-year
warranty

Ten-year or five-year limited warranty for products where expressly indicated on the corresponding catalogue page. For all other products, the European two-year legal guarantee shall apply. **See conditions on www.zown.com/warranty.**

Garantía limitada de 10 o 5 años para aquellos productos en los que así se indique en la correspondiente página del catálogo. Para el resto de productos será aplicable la garantía legal europea de 2 años. **Consultar condiciones en www.zown.com/warranty.**

10 ou 5 ans de garantie limitée pour tous les produits dont la description contient cette indication (veuillez vous reporter à la page correspondante du catalogue). Pour tous les autres produits, c'est la garantie légale européenne de deux ans qui sera appliquée. **Consulter les conditions sur www.zown.com/warranty.**

Auf Waren mit der entsprechenden Angabe auf der jeweiligen Katalogseite leisten wir 10 bzw. 5 Jahre beschränkte Garantie. Für die anderen Waren gilt die gesetzliche europäische Garantiefrist von 2 Jahren. **Bedingungen siehe www.zown.com/warranty.**



High-density polyethylene table top, chair or bench seat and backrest. Powder-coated steel frame.

Sobre de mesa, o asiento y respaldo de silla o banco, en polietileno de alta densidad. Estructura de acero pintado por pulverización.

Plateau de table, ou siège et dossier de chaise ou de banc, en polyéthylène haute densité. Structure en acier peint par pulvérisation.

Tischplatte bzw. Sitzfläche und Rückenlehne von Stuhl bzw. Bank aus HDPE. Gestell aus pulverbeschichtetem Stahl.

Light Grey / Gris Claro / Gris Clair / Hellgrau
Grey / Gris / Gris / Grau

Brown / Marrón / Marron / Braun
Green / Verde / Vert / Grün

White / Blanco / Blanc / Weiß
Black / Negro / Noir / Schwarz

White / Blanco / Blanc / Weiß
White / Blanco / Blanc / Weiß

Dark Bronze / Bronce Oscuro / Bronzé Foncé / Dunkle Bronze
Dark Bronze / Bronce Oscuro / Bronzé Foncé / Dunkle Bronze



Powder-coated steel frame. Grey.

Estructura de acero pintado por pulverización. Gris.

Structure en acier peint par pulvérisation. Gris.

Gestell aus pulverbeschichtetem Stahl. Grau.



Polypropylene chair seat and backrest. Powder-coated steel frame.

Asiento y respaldo de la silla de polipropileno. Estructura de acero pintado por pulverización.

Siège et dossier de la chaise en polypropylène. Structure en acier peint par pulvérisation.

Sitzfläche und Rückenlehne des Stuhls aus Polypropylen. Gestell aus pulverbeschichtetem Stahl.

Light Grey / Gris Claro / Gris Clair / Hellgrau
Grey / Gris / Gris / Grau

White / Blanco / Blanc / Weiß
White / Blanco / Blanc / Weiß

Black / Negro / Noir / Schwarz
Black / Negro / Noir / Schwarz



SS304: Stainless steel table.

Mesa de acero inoxidable SS304.

Table en acier inoxydable SS304.

SS304: Tisch aus Edelstahl.

Upholstered seat and backrest. Powder-coated steel frame.

Asiento y respaldo tapizados. Estructura de acero pintado por pulverización.

Siège et dossier rembourrés. Structure en acier peint par pulvérisation.

Sitzfläche und Rückenlehne gepolstert. Gestell aus pulverbeschichtetem Stahl.

Black / Negro / Noir / Schwarz
Silver / Plata / Argent / Silber

Blue / Azul / Bleu / Blau
Silver / Plata / Argent / Silber

Black / Negro / Noir / Schwarz
Gold / Dorado / Doré / Gold

Grey / Gris / Gris / Grau
Silver / Plata / Argent / Silber

Red / Rojo / Rouge / Rot
Silver / Plata / Argent / Silber

Black / Negro / Noir / Schwarz
Black / Negro / Noir / Schwarz



Evenly distributed maximum weight load the table can withstand for 24 hours without causing severe deformation that would prevent its use.

Peso máximo recomendado uniformemente repartido que puede soportar la mesa durante 24h sin causar un grado de deformación severo que impida su uso.

Poids maximum recommandé, réparti de façon uniforme, supporté par la table pendant 24 h sans provoquer de déformation sévère susceptible d'empêcher son utilisation.

Maximal empfohlene Last, der der Tisch bei gleichmäßiger Lastverteilung 24 Stunden lang standhält, ohne starke Verformungen zu erleiden, die seine Einsatztauglichkeit gefährden.



Recommended maximum weight.

Peso máximo recomendado.

Poids maximum recommandé.

Empfohlenes Höchstgewicht.



Net product weight.

Peso neto del producto.

Poids net du produit.

Nettogewicht des Artikels.



UV-protected and water-resistant. Ideal for extensive but not permanent outdoor use.

Protección UV y Hidrófuga. Ideal para uso exterior extensivo, pero no permanente.

Protection UV et hydrofuge. Idéal pour un usage extérieur extensif, mais non permanent.

UV-geschützt und wasserabstoßend. Ideal zur extensiven, aber nicht dauernden Verwendung im Freien.



Seating capacity of the table.

Máximo número recomendado de comensales por mesa.

Nombre maximum recommandé de personnes par table.

Anzahl der Sitzplätze pro Tisch.



Conference table with ergonomic frame.
Mesa para conferencias con estructura ergonómica.
Table pour conférences avec une structure ergonomique.
Konferenztisch mit ergonomischem Gestell.

M183

TABLE MESA TABLE TISCH



3



10.7 kg
23.59 lb



225 kg
500 lb



Water-resistant



HOPE Light Grey
POWDER-COATED STEEL Grey

Limited
10-year
warranty

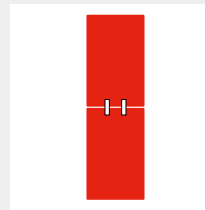

Longitudinal table joining system.
Sistema de unión longitudinal de mesas.
Système de raccord longitudinal de tables.
Vorrichtung zur längsseitigen Verbindung der Tische.

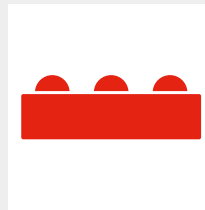

Capacity: 3 persons.
Area per person: 24".
Capacidad: 3 personas.
Espacio por persona: 61 cm.
Capacité: 3 personnes.
Espace par personne: 61 cm.
Bietet Platz für 3 Personen.
Platz pro Person: 61 cm.



Ergonomic frame design.
Diseño ergonómico de la estructura.
Design ergonomique de la structure.
Ergonomisches Gestelldesign.



XXL trolley available for 24 tables. See page 58.
Carro XXL trolley disponible para 24 mesas. Ver pág. 58.
Chariot XXL trolley disponible pour 24 tables. Voir page 58.
Wagen XXL trolley lieferbar für 24 Tische. Siehe S.58.



Ergonomic frame design.
Diseño ergonómico de la estructura.
Design ergonomique de la structure.
Ergonomisches Gestelldesign.



XXL trolley available for 24 tables. See page 58.
Carro XXL trolley disponible para 24 mesas. Ver pág. 58.
Chariot XXL trolley disponible pour 24 tables. Voir page 58.
Wagen XXL trolley lieferbar für 24 Tische. Siehe S.58.

Conference table with wheels, folding table top and modesty panel.
Mesa para conferencias con ruedas, sobre abatible y panel de intimidad.
Table pour conférences à roulettes, surface rabattable et panneau de séparation.
Konferenztisch mit Rädern, klappbarer Tischplatte und Fußraumblende.

oxford180

TABLE MESA TABLE TISCH



3



22.4 kg
49.4 lb



315 kg
694 lb



Water-resistant



HOPE Light Grey
POWDER-COATED STEEL Grey

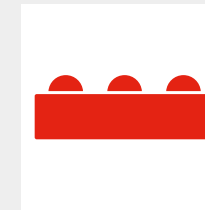

Capacity: 3 persons.
Area per person: 24".
Capacidad: 3 personas.
Espacio por persona: 61 cm.
Capacité: 3 personnes.
Espace par personne: 61 cm.
Bietet Platz für 3 Personen.
Platz pro Person: 61 cm.



Lightweight appearance thanks to the table top's design.
El diseño del sobre confiere ligereza visual.
Légèreté visuelle grâce au design du plateau.
Leichtes Aussehen dank speziellem Plattendesign.



Two cable tidy grommets.
Dos orificios con embellecedor para el paso de los cables.
Deux passe-câbles esthétiques.
Zwei Kabelöffnungen mit Abdeckblende.



Modesty panel with cable tray.
Panel frontal de intimidad con bandeja sujeta-cables.
Voile de fond munie d'une tablette faisant passer les câbles.
Sichtschutzblende mit Kabelwanne.

thetextilecollection

stretch



table cover	1192	1196	1194	1195	1193	1197	1198
top cover	0445	0844	0842	0841	0442	0843	0441

paramount



table cover	0123	0848	0847	0126	0124	0128	0127
tablecloth	0549						

232x96 cm
91.35"x37.8"

plain



table cover	0338	0846	0845	0341	0339	0343	0342
tablecloth	0549						

232x96 cm
91.35"x37.8"



Hinged table top with a special mechanism for folding the table gently and smoothly. Compact storage of multiple tables when locked in the upright position.
Sobre abatible con mecanismo especial para un descenso suave sin impacto. Con el sobre bloqueado en posición vertical, las mesas se acoplan economizando espacio.
Plateau rabattable à l'aide d'un mécanisme spécial pour un abaissement en douceur, sans impact. Lorsque le plateau est bloqué en position verticale, les tables peuvent se raccorder, ce qui économise de l'espace.
Klappbare Platte mit Spezialvorrichtung zum sanften, stoßlosen Einklappen. Platzsparende Aufbewahrung mehrerer Tische mit senkrecht verriegelter Platte.

Code Código Code Code	EAN	Name Nombre Nom Name	Units per box Unidades por caja Unités par boîte Stückzahl pro Packung	Packaging size Medidas embalaje Dimensions emballage Verpackungsmaße	Packaging volume Volumen embalaje Volume d'emballage Verpackungsvolumen	Gross weight Peso bruto Poids brut Bruttogewicht	Loading quantity Unidades por contenedor Unités par conteneur Einheiten pro Container
PT-033	8436539296577	M183	1	185.4 x 47.6 x 5.7 cm 73" x 18.7" x 2.3"	0.050 m ³ 1.776 ft ³	12.47 kg 27.43 lb	Container 40': 1100 Container 40' HC: 1220

Code Código Code Code	EAN	Name Nombre Nom Name	Units per box Unidades por caja Unités par boîte Stückzahl pro Packung	Packaging size Medidas embalaje Dimensions emballage Verpackungsmaße	Packaging volume Volumen embalaje Volume d'emballage Verpackungsvolumen	Gross weight Peso bruto Poids brut Bruttogewicht	Loading quantity Unidades por contenedor Unités par conteneur Einheiten pro Container
PT-035	8436539296584	oxford180	1	181.9 x 58.4 x 12.7 cm 71.6" x 23" x 5"	0.1349 m ³ 4.763 ft ³	25.29 kg 55.64 lb	Container 40': 446 Container 40' HC: 508

Multi-purpose side table.
Mesa auxiliar multiusos.
Table auxiliaire multi-usages.
Mehrzweck-Beistelltisch.

L120

TABLE MESA TABLE TISCH



8.5 kg
18.7 lb



205 kg
450 lb



Water-resistant



HDPE Light Grey
POWDER-COATED STEEL Grey

Limited
10-year
warranty

Special trolley for the L120 table.
Carro especial para la mesa L120.
Chariot spécial pour la table L120.
Spezialwagen für den Tisch L120.

Ltrolley

TROLLEY CARRO CHARIOT WAGEN



21.3 kg
46.9 lb



POWDER-COATED STEEL Grey



L131.7 x W62 cm
L51.9" x W24.4"



Sliding ring to lock the legs in position when in use. Easy and secure.

Argolla autodeslizante para bloquear las patas en posición de uso. Fácil y seguro.

Anneau autoglissant pour blocage des pieds en position d'usage. Facile et sûr.

Selbstgleitender Metallschiebering zur Feststellung der aufgeklappten Tischbeine. Einfach und sicher.



Ltrolley available for 20 tables. See page 31.

Carro Ltrolley disponible para 20 mesas. Ver pág. 31.

Chariot Ltrolley disponible pour 20 tables. Voir page 31.

Wagen Ltrolley lieferbar für 20 Tische. Siehe S. 31.



Peripheral posts to hold the stacked tables in place.

Postes périphériques pour immobiliser les tables apiladas.

Poteaux périphériques pour immobiliser des tables empilées.

Sicherungsstangen verhindern das Verrutschen der gestapelten Tische.



Handle specially designed to protect the hands.

Asa especial para proteger las manos.

Anse spécialement conçue pour protéger les mains.

Ein spezieller Griff schützt die Hände.



Four polyurethane wheels with built-in brake. (Two fixed wheels and two pivoting wheels).

4 ruedas de poliuretano con freno incorporado (2 ruedas fijas y 2 ruedas pivotantes).

4 roulettes en polyuréthane avec frein intégré. (2 roulettes fixes et 2 roulettes pivotantes).

4 PU-Räder mit integrierter Bremse. (2 feststehende Räder und 2 Schwenkräder).

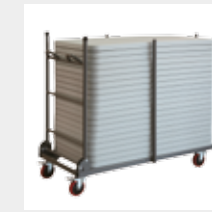

Capacity: 20 pcs. L120.

Capacidad: 20u. L120.

Capacité: 20u. L120.

Fassungsvermögen: 20 Stk. L120.

thetextilecollection

stretch



paramount



plain



table cover 0205 0852 0850 0849 0202 0851 0201

top cover 0438 0856 0854 0853 0435 0855 0434



table cover 0117 0860 0859 0120 0118 0122 0121

tablecloth 0548

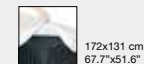

172x131 cm
67.7"x51.6"

table cover 0332 0858 0857 0335 0333 0337 0336

tablecloth 0548

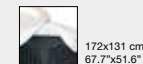

172x131 cm
67.7"x51.6"



Part to hold the removable posts when folded. Bar with automatic unlocking mechanism which allows the vertical bracket to be folded. Trolley in fully folded position. Occupies a minimum of space. All parts are integrated to prevent loss.

Pieza para sujetar los postes extraíbles en posición de plegado. Barra con mecanismo automático para desbloquear y permitir el plegado del soporte vertical. Carro totalmente plegado. Ocupa mínimo espacio y todos sus componentes quedan integrados para no extraviarlos.

Pièce pour poteaux extractibles en position de pliage. Barre avec mécanisme automatique pour blocage et déblocage et pour permettre le pliage du support vertical. Chariot entièrement plié. Occupe peu de place. Tous ses composants sont intégrés pour ne pas les perdre.

Haltevorrichtung für die herausnehmbaren Stangen in abgeklappter Position. Stange mit automatischem Mechanismus zum Entriegeln und Zusammenklappen des senkrechten Gestells. Der Wagen lässt sich vollständig zusammenklappen. Platzsparend sind alle Bestandteile integriert, damit sie nicht verloren gehen.

Code Código Code Code	EAN	Name Nombre Nom Name	Units per box Unidades por caja Unités par boîte Stückzahl pro Packung	Packaging size Medidas embalaje Dimensions emballage Verpackungsmaße	Packaging volume Volumen embalaje Volume d'emballage Verpackungsvolumen	Gross weight Peso bruto Poids brut Bruttogewicht	Loading quantity Unidades por contenedor Unités par conteneur Einheiten pro Container
BT-04B	8437009886151	L120	1	124.8 x 63.5 x 6 cm 49.1" x 25" x 2.4"	0.048 m ³ 1.695 ft ³	9.8 kg 21.56 lb	Container 40': 1270 Container 40' HC: 1500

Code Código Code Code	EAN	Name Nombre Nom Name	Units per box Unidades por caja Unités par boîte Stückzahl pro Packung	Packaging size Medidas embalaje Dimensions emballage Verpackungsmaße	Packaging volume Volumen embalaje Volume d'emballage Verpackungsvolumen	Gross weight Peso bruto Poids brut Bruttogewicht	Loading quantity Unidades por contenedor Unités par conteneur Einheiten pro Container
RA-101A	8437009886014	Ltrolley	1	138.4 x 72.4 x 15.2 cm 54.5" x 28.5" x 6"	0.152 m ³ 5.367 ft ³	23.9 kg 52.5 lb	Container 40': 409 Container 40' HC: 440



XL150

TABLE MESA TABLE TISCH



Limited 10-year warranty



H74.3 cm
H29.2"

45 mm

L152.4 x W76.2 cm
L5' x W30"

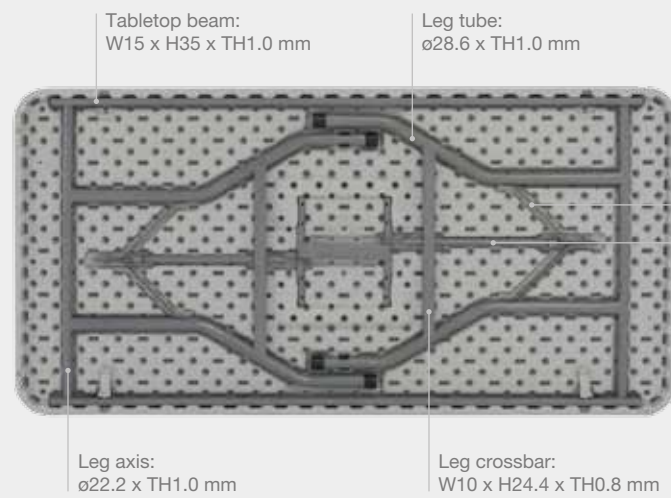

Tabletop beam:
W15 x H35 x TH1.0 mm

Leg tube:
ø28.6 x TH1.0 mm

Connecting rod:
TH2.8 mm

Brace tube:
ø18 x TH1.4 mm

Leg axis:
ø22.2 x TH1.0 mm

Leg crossbar:
W10 x H24.4 x TH0.8 mm

Table with transverse joining system, ideal for 152 x 152 cm square configurations, joining two tables.
Mesa con sistema de unión transversal ideal para composiciones cuadradas de 152 x 152 cm uniendo dos mesas.
Table dotée d'un système de raccord transversal, idéal pour des modules carrés de 152 par 152 cm servant à relier deux tables.
Tisch mit Querverbindungssystem, ideal für eine quadratische Anordnung zweier Tische (152 x 152 cm).

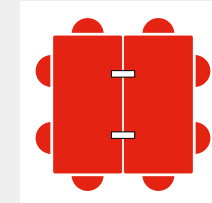

Transverse table joining system.
Sistema de unión transversal de mesas.
Système de raccord transversal de tables.
Vorrichtung zur querseitigen Verbindung der Tische.

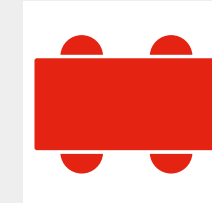

Capacity: 4 persons.
Area per person: 29.9".
Capacidad: 4 personas.
Espacio por persona: 76 cm.
Capacité: 4 personnes.
Espace par personne: 76 cm.
Bietet Platz für 4 Personen.
Platz pro Person: 76 cm.

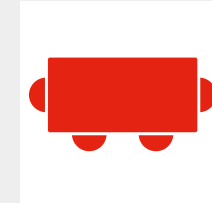

Capacity: 4 persons.
Area per person: 24".
Capacidad: 4 personas.
Espacio por persona: 61 cm.
Capacité: 4 personnes.
Espace par personne: 61 cm.
Bietet Platz für 4 Personen.
Platz pro Person: 61 cm.

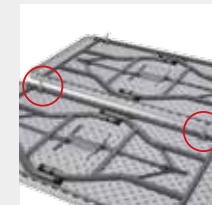

Transverse table joining system.
Sistema de unión transversal de mesas.
Système de raccord transversal de tables.
Vorrichtung zur querseitigen Verbindung der Tische.



Sliding ring to lock the legs in position when in use. Easy and secure.
Argolla autodeslizante para bloquear las patas en posición de uso. Fácil y seguro.
Anneau autoglissant pour blocage des pieds en position d'usage. Facile et sûr.
Selbstgleitender Metallschieber zur Feststellung der aufgeklappten Tischbeine. Einfach und sicher.

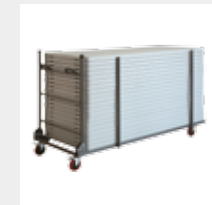

XLtrolley available for 20 tables. See page 44.
Carro XLtrolley disponible para 20 mesas. Ver pág. 44.
Chariot XLtrolley disponible pour 20 tables. Voir page 44.
Wagen XLtrolley lieferbar für 20 Tische. Siehe S.44.

thetextilecollection

stretch



paramount



plain

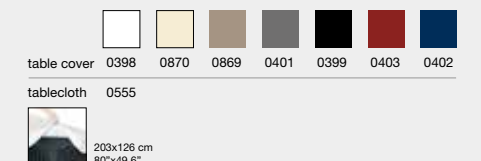
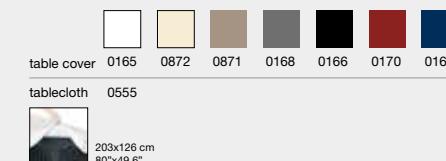
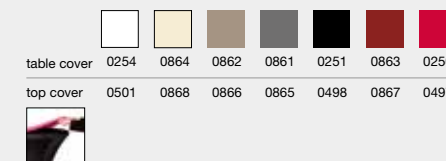

Code Código Code Code	EAN	Name Nombre Nom Name	Units per box Unidades por caja Unités par boîte Stückzahl pro Packung	Packaging size Medidas embalaje Dimensions emballage Verpackungsmaße	Packaging volume Volumen embalaje Volume d'emballage Verpackungsvolumen	Gross weight Peso bruto Poids brut Bruttogewicht	Loading quantity Unidades por contenedor Unités par conteneur Einheiten pro Container
BT-05BK	8437009886168	XL150	1	155.3 x 78 x 6.4 cm 61" x 30.7" x 2.4"	0.077 m ³ 2.719 ft ³	13.15 kg 28.93 lb	Container 40': 850 Container 40' HC: 940

XL180

TABLE MESA TABLE TISCH

6
 14 kg / 30.9 lb
 315 kg / 694 lb
 Water-resistant
 HDPE Light Gray
 POWDER-COATED STEEL Gray

Limited 10-year warranty



H74.3 cm
H29.2"

45 mm

L182.9 x W75.2 cm
L6' x W29.6"

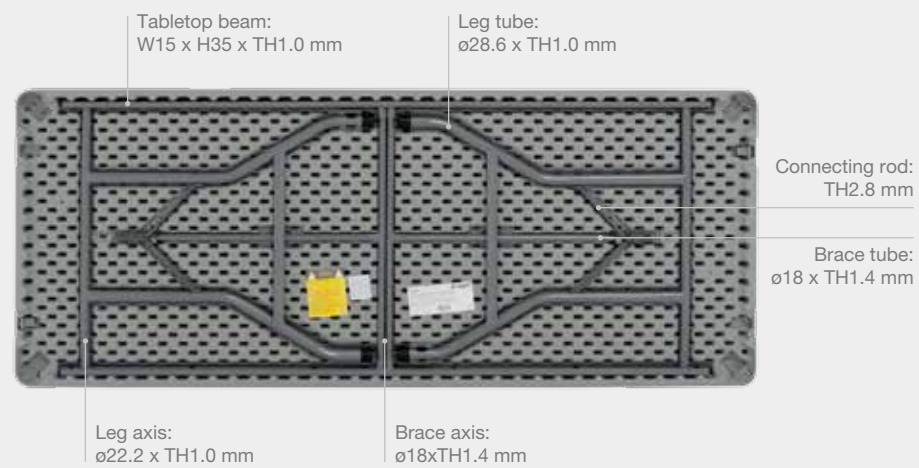
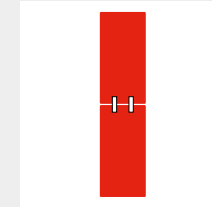
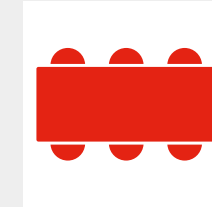

Table with longitudinal joining system.
Mesa con sistema de unión longitudinal.
Table avec système de raccord longitudinal.
Tisch mit Längsverbindungssystem.



Longitudinal table joining system.
Sistema de unión longitudinal de mesas.
Système de raccord longitudinal de tables.
Vorrichtung zur längsseitigen Verbindung der Tische.



Capacity: 6 persons.
Area per person: 24".
Capacidad: 6 personas.
Espacio por persona: 61 cm.
Capacité: 6 personnes.
Espace par personne: 61 cm.
Bietet Platz für 6 Personen.
Platz pro Person: 61 cm.



Longitudinal table joining system.
Sistema de unión longitudinal de mesas.
Système de raccord longitudinal de tables.
Vorrichtung zur längsseitigen Verbindung der Tische.



Sliding ring to lock the legs in position when in use. Easy and secure.
Argolla autodeslizante para bloquear las patas en posición de uso. Fácil y seguro.
Anneau autoglissant pour blocage des pieds en position d'usage. Facile et sûr.
Selbstgleitender Metallschieber zur Feststellung der aufgeklappten Tischbeine. Einfach und sicher.



XLtrolley available for 20 tables. See page 44.
Carro XLtrolley disponible para 20 mesas. Ver pág. 44.
Chariot XLtrolley disponible pour 20 tables. Voir page 44.
Wagen XLtrolley lieferbar für 20 Tische. Siehe S.44.

thetextilecollection

stretch



table cover: 0261 0876 0874 0873 0258 0875 0257
 top cover: 0508 0880 0878 0877 0505 0879 0504

paramount



table cover: 0171 0884 0883 0174 0172 0176 0175
 tablecloth: 0556
 232x126 cm / 91.3"x49.6"

plain

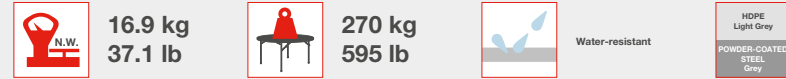

table cover: 0404 0882 0881 0407 0405 0409 0408
 tablecloth: 0556
 232x126 cm / 91.3"x49.6"

Code Código Code Code	EAN	Name Nombre Nom Name	Units per box Unidades por caja Unités par boîte Stückzahl pro Packung	Packaging size Medidas embalaje Dimensions emballage Verpackungsmaße	Packaging volume Volumen embalaje Volume d'emballage Verpackungsvolumen	Gross weight Peso bruto Poids brut Bruttogewicht	Loading quantity Unidades por contenedor Unités par conteneur Einheiten pro Container
BT-06BK	8437009886021	XL180	1	185.4 x 77 x 6.4 cm 73" x 30.6" x 2.5"	0.092 m ³ 3.248 ft ³	16 kg 35.2 lb	Container 40': 700 Container 40' HC: 800

worktop180

TABLE MESA TABLE TISCH



H74.3 / 85.1 / 90.2 / 94.3 cm
H29.2" / 33.5" / 35.5" / 37.1"



L182.9 x W75.2 cm
L6' x W29.6"



Foldable table height-adjustable in four positions. By selecting its higher positions, it is ideal as a work surface for performing tasks while standing. Mesa plegable de altura ajustable a 4 posiciones. Seleccionando sus posiciones más altas, resulta ideal como superficie de trabajo para tareas que se realicen estando de pie. Table pliable à hauteur réglable selon 4 positions. Les positions les plus hautes permettent de s'en servir comme plan de travail, idéal pour réaliser des tâches debout. Klapptisch, höhenverstellbar in 4 Positionen. Bei Einstellung einer der hohen Positionen ist der Tisch ideal als Arbeitsfläche für stehend ausgeführte Tätigkeiten.

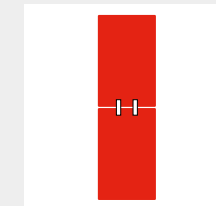

Longitudinal table joining system.
Sistema de unión longitudinal de mesas.
Système de raccord longitudinal de tables.
Vorrichtung zur längsseitigen Verbindung der Tische.



Longitudinal table joining system.
Sistema de unión longitudinal de mesas.
Système de raccord longitudinal de tables.
Vorrichtung zur längsseitigen Verbindung der Tische.

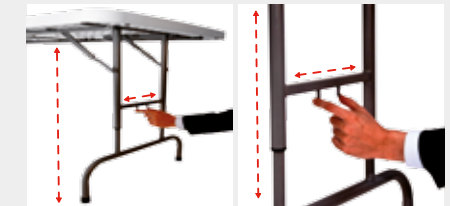

Practical mechanism for adjusting the table height.
Práctico mecanismo para ajustar la altura de la mesa.
Mécanisme pratique pour régler la hauteur de la table.
Praktische Vorrichtung zum Einstellen der Tischhöhe.



Manual lock (1) and sliding ring (2) for greater leg stability when in use.
Bloqueador manual (1) y argolla autodeslizante (2) para mayor seguridad de las patas en posición de uso.
Blocage manuel (1) et anneau autoglissant (2) pour plus de sécurité des pieds en position d'usage.
Manuelle Feststellung (1) und selbstgleitender Metallschieber (2) für eine höhere Sicherheit der Tischbeine in aufgeklappter Position.



XLtrolley available for 20 tables. See page 44.
Carro XLtrolley disponible para 20 mesas. Ver pág. 44.
Chariot XLtrolley disponible pour 20 tables. Voir page 44.
Wagen XLtrolley lieferbar für 20 Tische. Siehe S. 44.



Ideal as a work surface.
Ideal como superficie de trabajo.
Idéal comme plan de travail.
Ideal als Arbeitsfläche.

thetextilecollection

stretch



paramount



plain



Valid for the worktop180 table at a height of 74.3 cm/29.2" / Válido para mesa worktop180 en altura 74.3 cm/29.2" / Uniquement pour le table de hauteur 74.3 cm/29.2" / Gültig für Tisch worktop180 mit 74.3 cm/29.2" Höhe

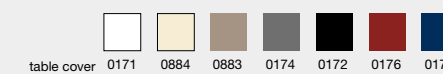

232x126 cm
91.3"x49.6"



232x126 cm
91.3"x49.6"

Code Código Code Code	EAN	Name Nombre Nom Name	Units per box Unidades por caja Unités par boîte Stückzahl pro Packung	Packaging size Medidas embalaje Dimensions emballage Verpackungsmaße	Packaging volume Volumen embalaje Volume d'emballage Verpackungsvolumen	Gross weight Peso bruto Poids brut Bruttogewicht	Loading quantity Unidades por contenedor Unités par conteneur Einheiten pro Container
BT-06A-002	8437010781841	worktop180	1	185.4 x 77.8 x 6.4 cm 73" x 30.6" x 2.5"	0.092 m ³ 3.248 ft ³	19.5 kg 42.9 lb	Container 40': 700 Container 40' HC: 800

Table with wheels and bottom rack for storage. It can be turned into a buffet table by joining it to the "Top Shelf" model.
 Mesa con ruedas y estante inferior para almacenaje. Puede convertirse en una mesa buffet acoplándole un "Top Shelf".
 Table à roulettes avec une étagère de rangement dans la partie inférieure. Elle peut se transformer en table de buffet au moyen d'un « Top Shelf ».
 Tisch mit Rädern und Unterregal zur Ablage. Kann in Verbindung mit einem „Top Shelf“ in einen Büfett-Tisch verwandelt werden.

buffettablebase

TABLE MESA TABLE TISCH



19.15 kg
42.13 lb



150 kg
330 lb



Water-resistant



Limited
10-year
warranty

topshelf180

SHELF ESTANTE SHELF SHELF



7.2 kg
15.87 lb



70 kg
155 lb



Water-resistant



H74 cm
H29.1"



L183.3 x W75.2 cm
L72.1" x W29.6"



H31 cm
H12.2"



L184 x W30.5 cm
L6' x W12"

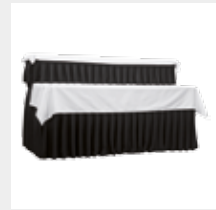

Ideal for displaying food in buffet services.
 Ideal para la disposición de alimentos en servicios de buffet.
 Idéal pour disposer différents plats lors d'un buffet.
 Ideal zum Anrichten von Speisen für Büfettis.



Ideal for use as a bar counter.
 Ideal para ser utilizado como mostrador de bar.
 Peut également être utilisée comme comptoir de bar.
 Ideal zur Verwendung als Bar-Theke.

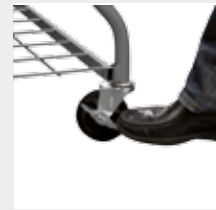

4 wheels with integrated brakes.
 4 ruedas con freno incorporado.
 4 roulettes avec frein.
 4 Räder mit integrierter Bremse.



Upper shelf that can be attached to an Buffet table base, XL180table, Sharp180table and the Worktop180 in order to turn the regular table into a buffet-table.
 Estante superior para ser unido a las mesas Buffet table base, XL180, Sharp180 y Worktop180 para convertirla en una mesa-buffet.
 Tablette supplémentaire avec système d'accroche pour monter les tables Buffet table base, XL180, Sharp180 et Worktop180 en buffet.
 Tischaufsatz für Tisch Buffet table base, XL180, Verwandelt den XL180, Sharp180 und Worktop180 Tischen in einen Büfettisch.

thetextilecollection

paramount



table cover 0105 0888 0887 0108 0106 0110 0109

plain



table cover 0320 0886 0885 0323 0321 0325 0324

tablecloth 0546
 232 x 126 cm (table)
 232 x 80 cm (top shelf)
 91.3" x 49.6" (table)
 91.3" x 31.5" (top shelf)

thetextilecollection

paramount



table cover 0105 0888 0887 0108 0106 0110 0109

plain



table cover 0320 0886 0885 0323 0321 0325 0324

tablecloth 0546
 232 x 126 cm (table)
 232 x 80 cm (top shelf)
 91.3" x 49.6" (table)
 91.3" x 31.5" (top shelf)

Code Código Code Code	EAN	Name Nombre Nom Name	Units per box Unidades por caja Unités par boîte Stückzahl pro Packung	Packaging size Medidas embalaje Dimensions emballage Verpackungsmaße	Packaging volume Volumen embalaje Volume d'emballage Verpackungsvolumen	Gross weight Peso bruto Poids brut Bruttogewicht	Loading quantity Unidades por contenedor Unités par conteneur Einheiten pro Container
PT010X002	843653927413	buffettablebase	1	192.7 x 77.4 x 8.5 cm 75.8" x 30.5" x 3.3"	0.128 m ³ 4.520 ft ³	21.99 kg 48.38 lb	Container 40': 468 Container 40' HC: 520

Code Código Code Code	EAN	Name Nombre Nom Name	Units per box Unidades por caja Unités par boîte Stückzahl pro Packung	Packaging size Medidas embalaje Dimensions emballage Verpackungsmaße	Packaging volume Volumen embalaje Volume d'emballage Verpackungsvolumen	Gross weight Peso bruto Poids brut Bruttogewicht	Loading quantity Unidades por contenedor Unités par conteneur Einheiten pro Container
PT-26	8436539292470	topshelf180	1	197 x 32 x 6 cm 77.5" x 12.75" x 2.4"	0.037 m ³ 1.334 ft ³	8.5 kg 18.73 lb	Container 40': 1612 Container 40' HC: 1792

XL240

TABLE MESA TABLE TISCH

Table for eight diners.
Mesa para ocho comensales.
Table conçue pour huit personnes.
Tisch für acht Personen.



Limited
10-year
warranty

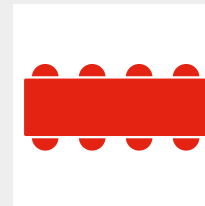

Capacity: 8 persons.
Area per person: 24".
Capacidad: 8 personas.
Espacio por persona: 61 cm.
Capacité: 8 personnes.
Espace par personne: 61 cm.
Bietet Platz für 8 Personen.
Platz pro Person: 61 cm.

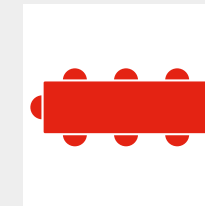

Capacity: 8 persons.
Area per person: 24".
Capacidad: 8 personas.
Espacio por persona: 61 cm.
Capacité: 8 personnes.
Espace par personne: 61 cm.
Bietet Platz für 8 Personen.
Platz pro Person: 61 cm.



L243.8 x W76.2 cm
L8' x W30"



Sliding ring to lock the legs in position when in use. Easy and secure.
Argolla autodeslizante para bloquear las patas en posición de uso. Fácil y seguro.
Anneau autoglissant pour blocage des pieds en position d'usage. Facile et sûr.
Selbstgleitender Metallschiebering zur Feststellung der aufgeklappten Tischbeine. Einfach und sicher.

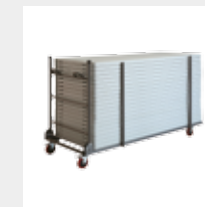

XLtrolley available for 18 tables. See page 44.
Carro XLtrolley disponible para 18 mesas. Ver pág. 44.
Chariot XLtrolley disponible pour 18 tables. Voir page 44.
Wagen XLtrolley lieferbar für 18 Tische. Siehe S.44.

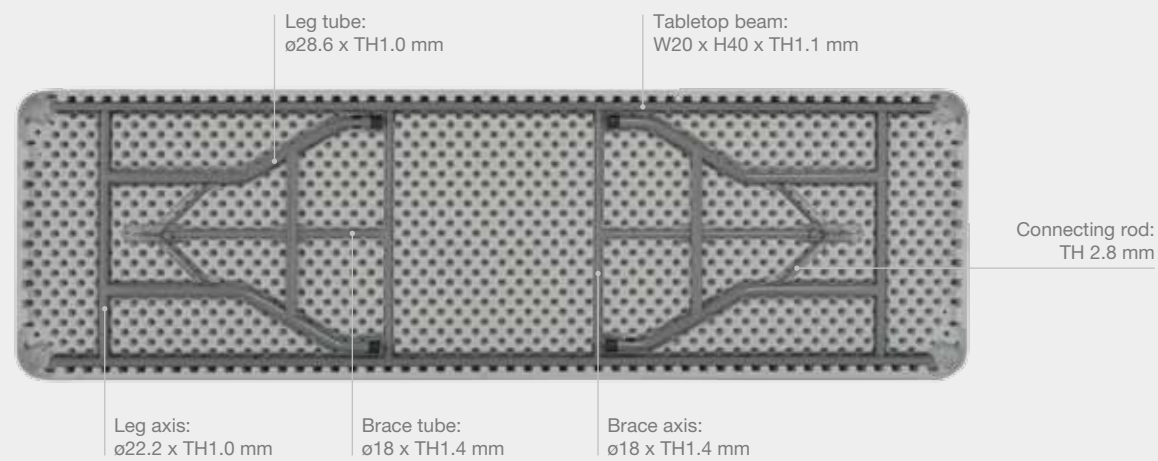

thetextilecollection

stretch



paramount



plain



Code Código Code Code	EAN	Name Nombre Nom Name	Units per box Unidades por caja Unités par boîte Stückzahl pro Packung	Packaging size Medidas embalaje Dimensions emballage Verpackungsmaße	Packaging volume Volumen embalaje Volume d'emballage Verpackungsvolumen	Gross weight Peso bruto Poids brut Bruttogewicht	Loading quantity Unidades por contenedor Unités par conteneur Einheiten pro Container
BT-08B	8437009886175	XL240	1	247.3 x 78 x 7.1 cm 97.4" x 30.6" x 2.8"	0.138 m ³ 4.873 ft ³	22 kg 48.4 lb	Container 40': 384 Container 40' HC: 540

table cover	0268	0892	0890	0889	0265	0891	0264
top cover	0515	0896	0894	0893	0512	0895	0511

table cover	0177	0900	0899	0180	0178	0182	0181
tablecloth	0557						
	294x126 cm 115.75"x49.6"						

table cover	0410	0898	0897	0413	0411	0415	0414
tablecloth	0557						
	294x126 cm 115.75"x49.6"						

Folding trolley with extendable base. Suitable for the XL150, XL180, XL240 and Worktop180 tables.
 Carro plegable con base extensible. Apto para las mesas XL150, XL180, XL240, Worktop180.
 Chariot pliant avec une base extensible. Compatible avec les tables XL150, XL180, XL240 et Worktop180.
 Klappwagen mit ausziehbarer Ladefläche. Geeignet für die Tische XL150, XL180, XL240, Worktop180.

XLtrolley

TROLLEY CARRO CHARIOT WAGEN



29.58 kg
65.22 lb



H115 cm
H45.3"



L(193 + 61) x W77 cm
L(76" + 24") x W30.3"



Peripheral posts to hold the stacked tables in place.

Postes périphériques pour immobiliser les tables empilées.

Poteaux périmétraux pour immobiliser les tables empilées.

Sicherungsstangen verhindern das Verrutschen der gestapelten Tische.



Expandable base to adjust to the respective table lengths.

Base extensible para adecuarla a la longitud de las distintas mesas.

Base extensible pour une adaptation à la longueur des différentes tables.

Die ausziehbare Ladefläche lässt sich an die jeweilige Tischlänge anpassen.



Handle specially designed to protect the hands.

Asa especial para proteger las manos.

Anse spécialement conçue pour protéger les mains.

Ein spezieller Griff schützt die Hände.



Four polyurethane wheels with built-in brake. (Two fixed wheels and two pivoting wheels).

4 ruedas de poliuretano con freno incorporado (2 ruedas fijas y 2 ruedas pivotantes).

4 roulettes en polyuréthane avec frein intégré. (2 roulettes fixes et 2 roulettes pivotantes).

4 PU-Räder mit integrierter Bremse. (2 feststehende Räder und 2 Schwenkräder).



Capacity: 20 pcs. XL150, 20 pcs. XL180, 20 pcs. worktop180, 18 pcs. XL240.

Capacidad: 20u. XL150, 20u. XL180, 20 pcs. worktop180, 18u. XL240.

Capacité: 20u. XL150, 20u. XL180, 20 pcs. worktop180, 18u. XL240.

Fassungsvermögen: 20 Stk. XL150, 20 Stk. XL180, 20 Stk. worktop180, 18 Stk. XL240.



Part to hold the removable posts when folded. Bar with automatic unlocking mechanism which allows the vertical bracket to be folded. Trolley in fully folded position. Occupies a minimum of space. All parts are integrated to prevent loss.

Pieza para sujetar los postes extraíbles en posición de plegado. Barra con mecanismo automático para desbloquear y permitir el plegado del soporte vertical. Carro totalmente plegado. Ocupa mínimo espacio y todos sus componentes quedan integrados para no extraviarlos.

Pièce pour les poteaux extractibles en position de pliage. Barre avec mécanisme automatique pour blocage et déblocage et pour permettre le pliage du support vertical. Chariot entièrement plié. Occupe peu de place. Tous ses composants sont intégrés pour ne pas les perdre.

Halterungsvorrichtung für die herausnehmbaren Stangen in abgeklappter Position. Stange mit automatischem Mechanismus zum Entriegeln und Zusammenklappen des senkrechten Gestells. Der Wagen lässt sich vollständig zusammenklappen. Platzsparend sind alle Bestandteile integriert, damit sie nicht verloren gehen.

Code Código Code Code	EAN	Name Nombre Nom Name	Units per box Unidades por caja Unités par boîte Stückzahl pro Packung	Packaging size Medidas embalaje Dimensions emballage Verpackungsmaße	Packaging volume Volumen embalaje Volume d'emballage Verpackungsvolumen	Gross weight Peso bruto Poids brut Bruttogewicht	Loading quantity Unidades por contenedor Unités par conteneur Einheiten pro Container
RA-102A	8437009886038	XLtrolley	1	198.1 x 87 x 15.2 cm 78" x 34.2" x 6"	0.262 m ³ 9.252 ft ³	35.35 kg 77.95 lb	Container 40': 229 Container 40' HC: 255



XLmoon

TABLE MESA TABLE TISCH

3-4
 18.6 kg / 41 lb
 300 kg / 661 lb
 Water-resistant
 HDPE Light Grey
 POWDER-COATED STEEL Grey
 Limited 10-year warranty

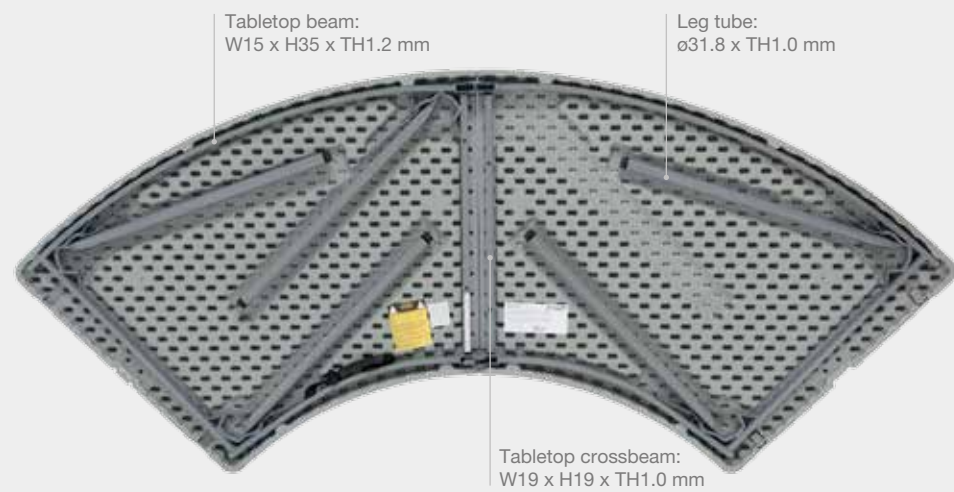
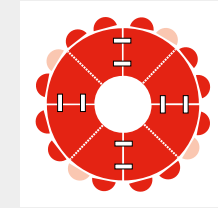
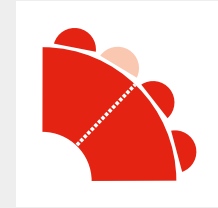

Table with circular joining system. It allows several configurations by combining it with "XL" tables or the Planet180 table.
 Mesa con sistema de unión circular. Permite varias composiciones combinándola con mesas rectangulares "XL" o con la mesa Planet180.
 Table avec système de raccord circulaire. Elle permet plusieurs compositions, avec des tables rectangulaires « XL » ou avec la table Planet180.
 Tisch mit Kreisverbindungssystem. Ermöglicht verschiedene Anordnungen durch Kombination mit den rechteckigen XL-Tischen bzw. dem Tisch Planet180.



Circular joining of four XLmoon tables with 1 planet180 table. Capacity for 12 to 16 persons.
 Unión circular de 4 mesas XLmoon con 1 mesa planet180. Capacidad 12 a 16 personas.
 Raccord circulaire de 4 tables XLmoon avec 1 table planet180. Capacité 12 à 16 personnes.
 Kreisförmige Verbindung von 4 Tischen XLmoon mit einem Tisch planet180. Bietet Platz für 12 bis 16 Personen.



Capacity: 3 or 4 persons. Area per person: 34" or 25".
 Capacidad: 3 o 4 personas. Espacio por persona: 87 o 65 cm.
 Capacité: 3 ou 4 personnes. Espace par personne: 87 ou 65 cm.
 Bietet Platz für 3 oder 4 Personen. Platz pro Person: 87 oder 65 cm.



Angular or circular table joining system.
 Sistema de unión angular o circular de mesas.
 Système de raccord d'angle ou raccord circulaire de tables.
 Vorrichtung zur winkel- und kreisförmigen Verbindung von Tischen.



Automatic leg lock when in use.
 Bloqueador automático de patas en posición de uso.
 Blocage automatique des pieds en position d'usage.
 Automatische Feststellung der aufgeklappten Tischbeine.



Height adjusters on 5 legs.
 Regulador de altura en las 5 patas.
 Régulateur de hauteur sur les 5 pieds.
 Integrierte Höhenverstellung in den 5 Tischbeinen.



Folding table top. Table provided with carrying handle.
 Sobre plegable. Mesa provista de un asa.
 Surface pliable. Table munie d'une anse.
 Der zusammengeklappte Tisch hat einen Tragegriff.

thetextilecollection

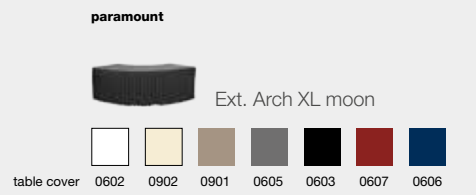
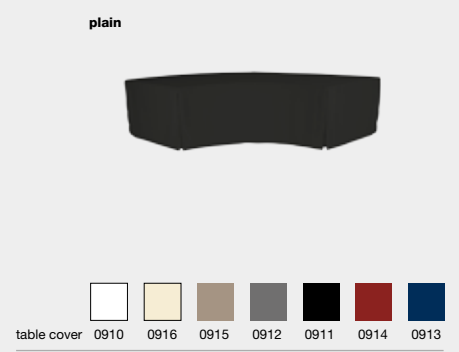
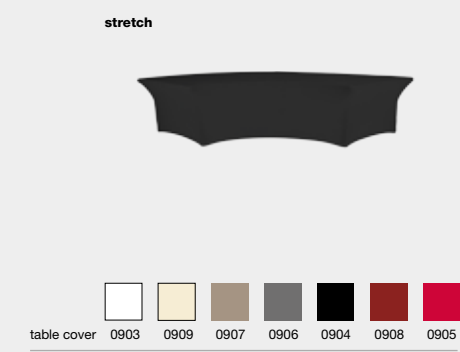

Code Código Code Code	EAN	Name Nombre Nom Name	Units per box Unidades por caja Unités par boîte Stückzahl pro Packung	Packaging size Medidas embalaje Dimensions emballage Verpackungsmaße	Packaging volume Volumen embalaje Volume d'emballage Verpackungsvolumen	Gross weight Peso bruto Poids brut Bruttogewicht	Loading quantity Unidades por contenedor Unités par conteneur Einheiten pro Container
PT-34	8437009886182	XLmoon	1	129.8 x 84.6 x 12 cm 51.1" x 33.3" x 4.7"	0.132 m³ 4.661 ft³	20.1 kg 44.22 lb	Container 40': 460 Container 40' HC: 520

XLcorner

TABLE MESA TABLE TISCH

1
 6.6 kg / 14.4 lb
 100 kg / 220 lb
 Water-resistant
 HDPE Light Grey
 POWDER-COATED STEEL Grey

Limited 10-year warranty



Table with angular joining system. It allows several configurations by combining it with rectangular "XL" tables.
Mesa con sistema de unión angular. Permite varias composiciones combinándola con mesas rectangulares "XL".
Table avec système de raccord d'angle. Elle permet différentes compositions avec des tables rectangulaires « XL ».
Tisch mit Eckverbindungssystem. Ermöglicht verschiedene Anordnungen durch Kombination mit den rechteckigen XL-Tischen.

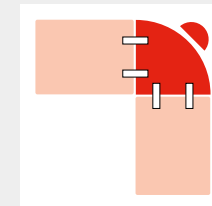

Capacity: 1 person.
Area per person: 47\"/>

Capacidad: 1 persona.
Espacio por persona: 119.4 cm.

Capacité: 1 personne.
Espace par personne: 119.4 cm.

Bietet Platz für 1 Person.
Platz pro Person: 119.4 cm.



Angular table joining system.
Sistema de unión angular de mesas.
Système de raccord d'angle de tables.
Vorrichtung zur winkelförmigen Verbindung von Tischen.



Automatic leg lock when in use.
Bloqueador automático de patas en posición de uso.
Blocage automatique des pieds en position d'usage.
Automatische Feststellung der aufgeklappten Tischbeine.



Height adjuster on 3 legs.
Regulador de altura incorporado en las 3 patas.
Régulateur de hauteur intégré aux 3 pieds.
Integrierte Höhenverstellung in den 3 Tischbeinen.



Telescopic leg for optimal folding.
Una pata telescópica para permitir un óptimo plegado.
Pied télescopique permettant un pliage optimal.
Ein zusammenschiebbares Tischbein ermöglicht ein optimales Zusammenklappen.

the textile collection

stretch

 table cover 0921 0927 0925 0924 0922 0926 0923

plain

 table cover 0928 0934 0933 0930 0929 0932 0931

paramount

 table cover 0596 0920 0919 0599 0597 0601 0600

tablecloth 0558
 125x125 cm
 49.25" x 49.25"
 quarter round

tablecloth 0558
 125x125 cm
 49.25" x 49.25"
 quarter round

Includes self-adhesive velcro to hold the skirt in place
 Incluye velcro auto-adhesivo para sujetar el faldo
 Fourni avec ruban auto-agrippant velcro pour fixer le jupon de table
 Mit selbstklebendem Klettband zur Befestigung des Tischvorhangs

Code Código Code Code	EAN	Name Nombre Nom Name	Units per box Unidades por caja Unités par boîte Stückzahl pro Packung	Packaging size Medidas embalaje Dimensions emballage Verpackungsmaße	Packaging volume Volumen embalaje Volume d'emballage Verpackungsvolumen	Gross weight Peso bruto Poids brut Bruttogewicht	Loading quantity Unidades por contenedor Unités par conteneur Einheiten pro Container
PT-32	8437009886045	XLcorner	2	78.1 x 76.8 x 14 cm 30.7" x 30.2" x 5.5"	0.083 m ³ 2.931 ft ³	14.6 kg 32.18 lb	Container 40': 1456 Container 40' HC: 1640

Square table with ergonomic legs.
 Mesa cuadrada con patas ergonómicas.
 Table carrée avec pieds ergonomiques.
 Quadratischer Tisch mit ergonomischen Füßen.

XXL90

TABLE MESA TABLE TISCH



Limited
10-year
 warranty

H74.3 cm
 H29.2"



L91.4 x W91.4 cm
 L36" x W36"

Tabletop beam:
 W15 x H30 x TH1.0 mm

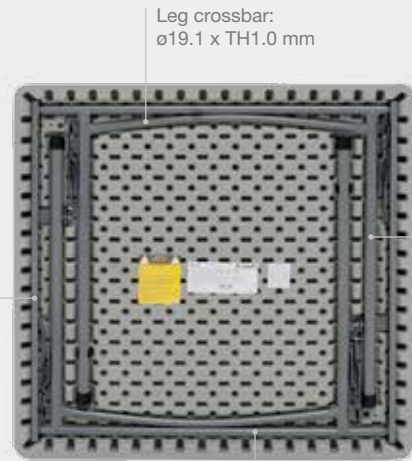

Leg crossbar:
 ø19.1 x TH1.0 mm

Leg tube:
 ø28.6 x TH1.0 mm

Leg axis:
 ø22.2 x TH1.0 mm

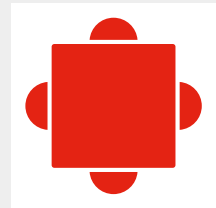

Capacity: 4 persons.
 Area per person: 24".
 Capacidad: 4 personas.
 Espacio por persona: 61 cm.
 Capacité: 4 personnes.
 Espace par personne: 61 cm.
 Bietet Platz für 4 Personen.
 Platz pro Person: 61 cm.



Ergonomic crosspieces for greater comfort.
 Travesaños ergonómicos para un mayor confort.
 Traverses ergonomiques pour plus de confort.
 Ergonomische Querstrebe für mehr Bequemlichkeit.



Manual lock (1) and sliding ring (2) for greater leg stability when in use.
 Bloqueador manual (1) y argolla autodeslizante (2) para mayor seguridad de las patas en posición de uso.
 Blocage manuel (1) et anneau autoglissant (2) pour plus de sécurité des pieds en position d'usage.
 Manuelle Feststellung (1) und selbstgleitender Metallschiebering (2) für eine höhere Sicherheit der Tischbeine in aufgeklappter Position.



XXLtrolley available for 28 tables (2 stacks of 14 tables). See page 58.
 Carro XXLtrolley disponible para 28 mesas (2 pilas de 14 mesas). Ver pág. 58.
 Chariot XXLtrolley disponible pour 28 tables (2 piles de 14 tables). Voir page 58.
 Wagen XXLtrolley für 28 Tische. (2 Stapel mit jeweils 14 Tischen). Siehe S.58.

the textile collection

stretch

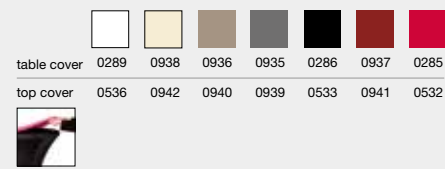

paramount

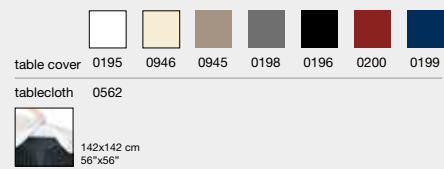

plain

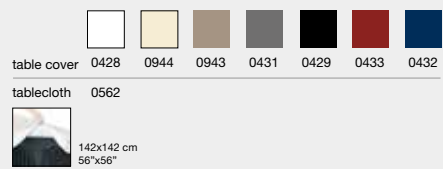

Code Código Code Code	EAN	Name Nombre Nom Name	Units per box Unidades por caja Unités par boîte Stückzahl pro Packung	Packaging size Medidas embalaje Dimensions emballage Verpackungsmaße	Packaging volume Volumen embalaje Volume d'emballage Verpackungsvolumen	Gross weight Peso bruto Poids brut Bruttogewicht	Loading quantity Unidades por contenedor Unités par conteneur Einheiten pro Container
BT-36	8437009886199	XXL90	1	93.4 x 94 x 6.4 cm 36.7" x 37" x 2.5"	0.056 m ³ 1.977 ft ³	11.8 kg 25.96 lb	Container 40': 1076 Container 40' HC: 1204

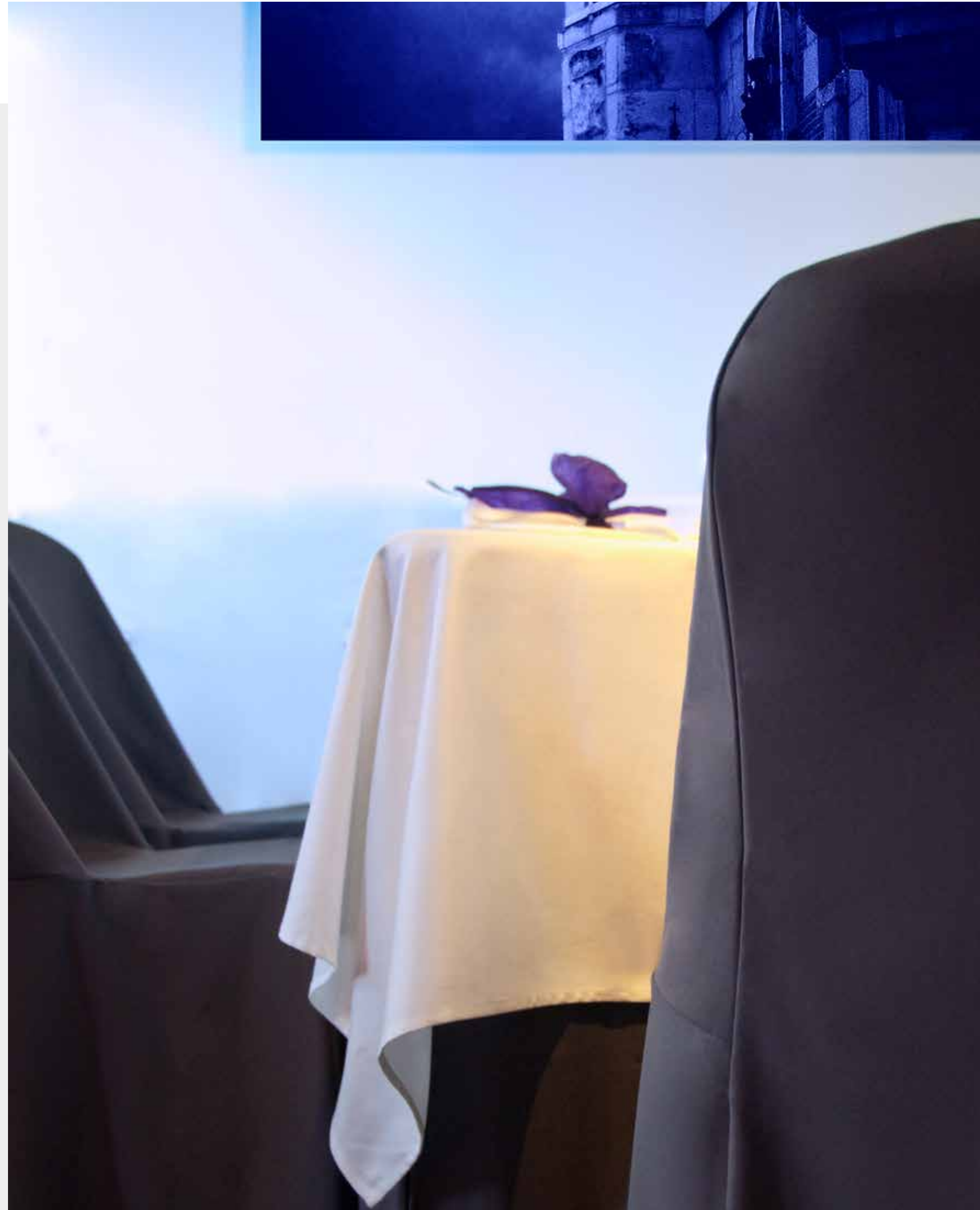

XXL200

TABLE MESA TABLE TISCH

Rectangular table with extra depth for greater comfort and longitudinal joining system.
Mesa rectangular con profundidad extra para mayor confort y con sistema de unión longitudinal.
Table rectangulaire plus large pour un plus grand confort, avec un système de raccord longitudinal.
Extra tiefer, rechteckiger Tisch für höheren Komfort, mit Längsverbindingssystem.



Limited
10-year
warranty



H74.3 cm
H29.2"

45 mm

L198.2 x W91.4 cm
L6.5' x W36"

Tabletop beam: W15 x H35 x TH1.5 mm
Brace axis: ø18 x TH1.4 mm
Brace tube: ø18 x TH1.4 mm

Leg crossbar: W10 x H24.4 x TH1.0 mm

Connecting rod: TH3.2 mm

Leg axis: ø25.4 x TH1.5 mm

Leg tube: ø28.6 x TH1.2 mm

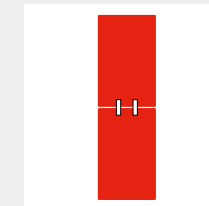
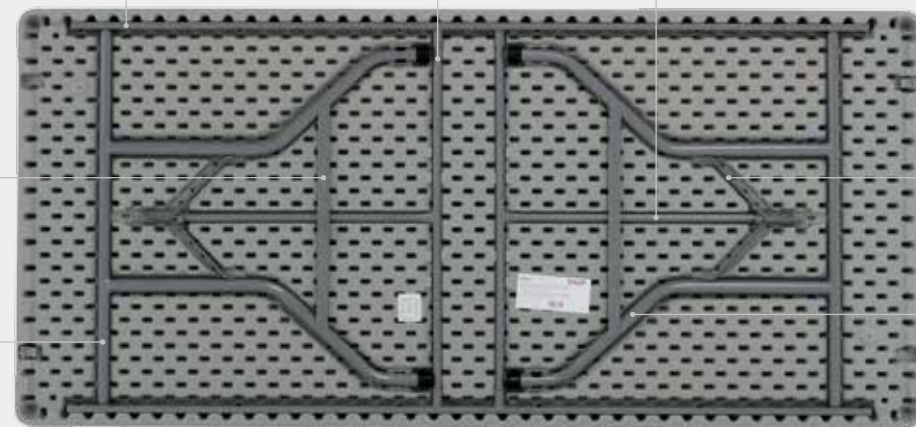

Longitudinal table joining system.
Sistema de unión longitudinal de mesas.
Système de raccord longitudinal de tables.
Vorrichtung zur längseitigen Verbindung der Tische.

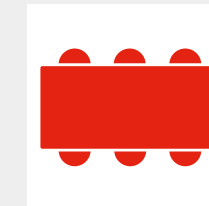

Capacity: 6 persons.
Area per person: 26".
Capacidad: 6 personas.
Espacio por persona: 66 cm.
Capacité: 6 personnes.
Espace par personne: 66 cm.
Bietet Platz für 6 Personen.
Platz pro Person: 66 cm.



Capacity: 6 persons.
Area per person: 27".
Capacidad: 6 personas.
Espacio por persona: 69 cm.
Capacité: 6 personnes.
Espace par personne: 69 cm.
Bietet Platz für 6 Personen.
Platz pro Person: 69 cm.



Longitudinal table joining system.
Sistema de unión longitudinal de mesas.
Système de raccord longitudinal de tables.
Vorrichtung zur längseitigen Verbindung der Tische.



Sliding ring to lock the legs in position when in use. Easy and secure.
Argolla autodeslizante para bloquear las patas en posición de uso. Fácil y seguro.
Anneau autoglissant pour blocage des pieds en position d'usage. Facile et sûr.
Selbstgleitender Metallschieber zur Feststellung der aufgeklappten Tischbeine. Einfach und sicher.



XXLtrolley available for 18 tables. See page 58.
Carro XXLtrolley disponible para 18 mesas. Ver pág. 58.
Chariot XXLtrolley disponible pour 18 tables. Voir page 58.
Wagen XXLtrolley für 18 Tische lieferbar. Siehe S. 58.

the textile collection

stretch



paramount



plain



Code Código Code Code	EAN	Name Nombre Nom Name	Units per box Unidades por caja Unités par boîte Stückzahl pro Packung	Packaging size Medidas embalaje Dimensions emballage Verpackungsmaße	Packaging volume Volumen embalaje Volume d'emballage Verpackungsvolumen	Gross weight Peso bruto Poids brut Bruttogewicht	Loading quantity Unidades por contenedor Unités par conteneur Einheiten pro Container
PT-29	8437009886052	XXL200	1	200.7 x 93.7 x 6.4 cm 79" x 36.9" x 2.5"	0.120 m ³ 4.237 ft ³	23 kg 50.6 lb	Container 40': 516 Container 40' HC: 576

table cover	0275	0950	0948	0947	0272	0949	0271
top cover	0522	0954	0952	0951	0519	0953	0518

table cover	0183	0958	0957	0186	0184	0188	0187
tablecloth	0560						
	248x142 cm 94.64"x56"						

table cover	0416	0956	0955	0419	0417	0421	0420
tablecloth	0560						
	248x142 cm 94.64"x56"						

XXL240

TABLE MESA TABLE TISCH



Limited
10-year
warranty



L240 x W91.4 cm
L8' x W36"

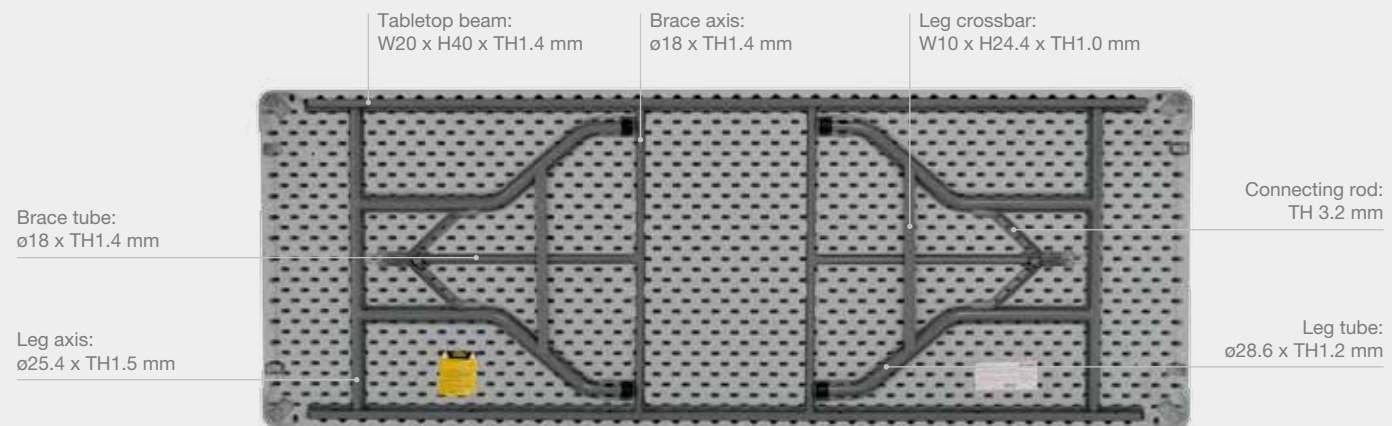

Rectangular table with extra depth for greater comfort and longitudinal joining system.
Mesa rectangular con profundidad extra para mayor confort y con sistema de unión longitudinal.
Table rectangulaire plus large pour un plus grand confort, avec un système de raccord longitudinal.
Extra tiefer, rechteckiger Tisch für höheren Komfort, mit Längsverbindingssystem.

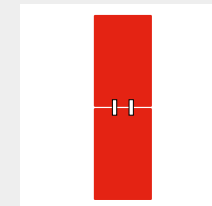

Longitudinal table joining system.
Sistema de unión longitudinal de mesas.
Système de raccord longitudinal de tables.
Vorrichtung zur längseitigen Verbindung der Tische.

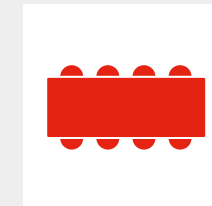

Capacity: 8 persons.
Area per person: 24".
Capacidad: 8 personas.
Espacio por persona: 61 cm.
Capacité: 8 personnes.
Espace par personne: 61 cm.
Bietet Platz für 8 Personen.
Platz pro Person: 61 cm.

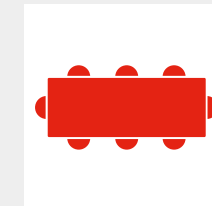

Capacity: 8 persons.
Area per person: 24".
Capacidad: 8 personas.
Espacio por persona: 61 cm.
Capacité: 8 personnes.
Espace par personne: 61 cm.
Bietet Platz für 8 Personen.
Platz pro Person: 61 cm.



Longitudinal table joining system.
Sistema de unión longitudinal de mesas.
Système de raccord longitudinal de tables.
Vorrichtung zur längseitigen Verbindung der Tische.



Sliding ring to lock the legs in position when in use. Easy and secure.
Argolla autodeslizante para bloquear las patas en posición de uso. Fácil y seguro.
Anneau autogissant pour blocage des pieds en position d'usage. Facile et sûr.
Selbstgleitender Metallschieber zur Feststellung der aufgeklappten Tischbeine. Einfach und sicher.



XXLtrolley available for 15 tables. See page 58.
Carro XXLtrolley disponible para 15 mesas. Ver pág. 58.
Chariot XXLtrolley disponible pour 15 tables. Voir page 58.
Wagen XXLtrolley für 15 Tische lieferbar. Siehe S. 58.

the textile collection

stretch



paramount



plain

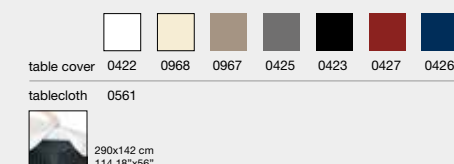
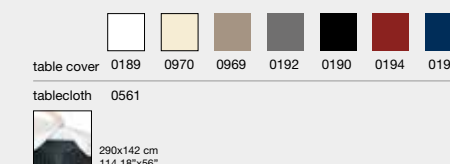
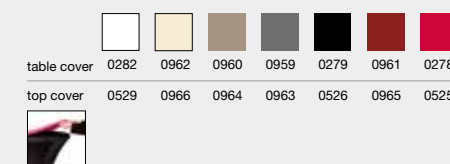

Code Código Code Code	EAN	Name Nombre Nom Name	Units per box Unidades por caja Unités par boîte Stückzahl pro Packung	Packaging size Medidas embalaje Dimensions emballage Verpackungsmaße	Packaging volume Volumen embalaje Volume d'emballage Verpackungsvolumen	Gross weight Peso bruto Poids brut Bruttogewicht	Loading quantity Unidades por contenedor Unités par conteneur Einheiten pro Container
PT-31	8437009886205	XXL240	1	242.6 x 93.7 x 7 cm 95.5" x 36.9" x 2.7"	0.159 m ³ 5.615 ft ³	28.4 kg 62.48 lb	Container 40': 370 Container 40' HC: 440

XXLcorner

TABLE MESA TABLE TISCH

Table with angular joining system. It allows several configurations by combining it with rectangular "XXL" tables.
 Mesa con sistema de unión angular. Permite varias composiciones combinándola con mesas rectangulares "XXL".
 Table avec système de raccord d'angle. Elle permet différentes compositions avec des tables rectangulaires « XXL ».
 Tisch mit Eckverbindungssystem. Ermöglicht verschiedene Anordnungen durch Kombination mit den rechteckigen XXL-Tischen.

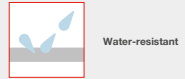

Limited
10-year
warranty

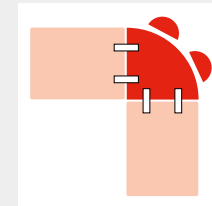

Capacity: 2 persons.
Area per person: 28".
 Capacidad: 2 personas.
Espacio por persona: 71.5 cm.
 Capacité: 2 personnes.
Espace par personne: 71.5 cm.
 Bietet Platz für 2 Personen.
Platz pro Person: 71.5 cm.



Angular table joining system.
 Sistema de unión angular de mesas.
 Système de raccord d'angle de tables.
 Vorrichtung zur winkelförmigen Verbindung von Tischen.



Automatic leg lock when in use.
 Bloquedor automático de patas en posición de uso.
 Blocage automatique des pieds en position d'usage.
 Automatische Feststellung der aufgeklappten Tischbeine.



Height adjuster on 3 legs.
 Regulador de altura incorporado en las 3 patas.
 Régulateur de hauteur intégré aux 3 pieds.
 Integrierte Höhenverstellung in den 3 Tischbeinen.

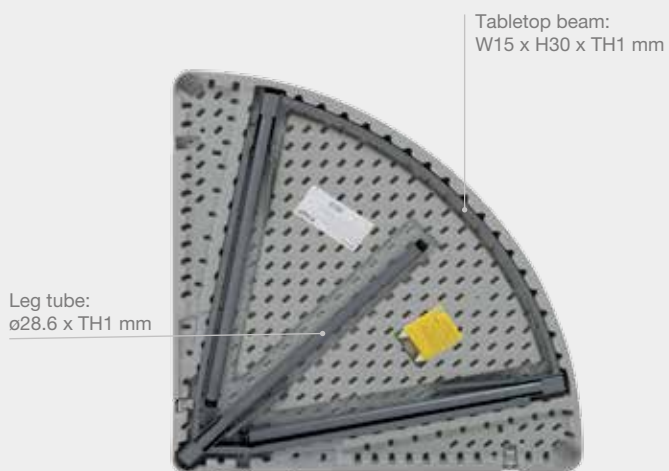

the textilecollection

stretch



plain



paramount



Ext. Arch XXL corner

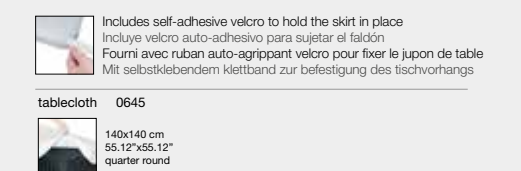
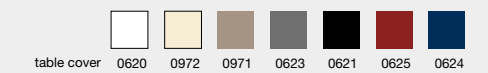
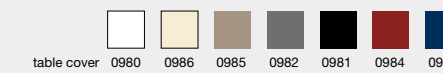
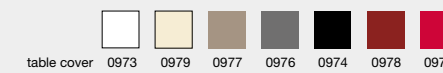

Code Código Code Code	EAN	Name Nombre Nom Name	Units per box Unidades por caja Unités par boîte Stückzahl pro Packung	Packaging size Medidas embalaje Dimensions emballage Verpackungsmaße	Packaging volume Volumen embalaje Volume d'emballage Verpackungsvolumen	Gross weight Peso bruto Poids brut Bruttogewicht	Loading quantity Unidades por contenedor Unités par conteneur Einheiten pro Container
PT-33	8437009886212	XXLcorner	1	93 x 94 x 6 cm 37" x 36.6" x 2.5"	0.052 m ³ 1.850 ft ³	9.8 kg 21.56 lb	Container 40': 1076 Container 40' HC: 1196

Folding trolley with extendable base. Suitable for the **XXL90**, **XXL200**, **XXL240** and **M183** tables.
 Carro plegable con base extensible. Apto para las mesas **XXL90**, **XXL200**, **XXL240** y **M183**.
 Chariot pliant avec une base extensible. Compatible avec les tables **XXL90**, **XXL200**, **XXL240** et **M183**.
 Klappwagen mit ausziehbarer Ladefläche. Geeignet für die Tische **XXL90**, **XXL200**, **XXL240** und **M183**.

XXL trolley

TROLLEY CARRO CHARIOT WAGEN



31.4 kg
69.2 lb



L(202 + 46) x W92 cm
L(79.6" + 18.1") x W36.2"



Peripheral posts to hold the stacked tables in place.

Postes périphériques pour immobiliser les tables empilées.

Poteaux périmétraux pour immobiliser les tables empilées.

Sicherungsstangen verhindern das Verrutschen der gestapelten Tische.

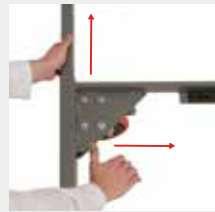

Expandable base to adjust to the respective table lengths.

Base extensible para adecuarla a la longitud de las distintas mesas.

Base extensible pour une adaptation à la longueur des différentes tables.

Die ausziehbare Ladefläche lässt sich an die jeweilige Tischlänge anpassen.



Special handle designed to protect the hands.

Asa especial para proteger las manos.

Anse spécialement conçue pour protéger les mains.

Ein spezieller Griff schützt die Hände.



Four polyurethane wheels with built-in brake. (Two fixed wheels and two pivoting wheels).

4 ruedas de poliuretano con freno incorporado (2 ruedas fijas y 2 ruedas pivotantes).

4 roulettes en polyuréthane avec frein intégré. (2 roulettes fixes et 2 roulettes pivotantes).

4 PU-Räder mit integrierter Bremse. (2 feststehende Räder und 2 Schwenkräder).



Capacity: 28 pcs. **XXL90**, 18 pcs. **XXL200**, 15 pcs. **XXL240**, 24 pcs. **M183**.

Capacidad: 28u. **XXL90**, 18u. **XXL200**, 15u. **XXL240**, 24u. **M183**.

Capacité : 28u. **XXL90**, 18u. **XXL200**, 15u. **XXL240**, 24u. **M183**.

Fassungsvermögen: 28 Stk. **XXL90**, 18 Stk. **XXL200**, 15 Stk. **XXL240**, 24 Stk. **M183**.



Part to hold the removable posts when folded. Bar with automatic unlocking mechanism which allows the vertical bracket to be folded. Trolley in fully folded position. Occupies a minimum of space. All parts are integrated to prevent loss.

Pieza para sujetar los postes extraíbles en posición de plegado. Barra con mecanismo automático para desbloquear y permitir el plegado del soporte vertical. Carro totalmente plegado. Ocupa mínimo espacio y todos sus componentes quedan integrados para no extraviarlos.

Pièce pour les poteaux extractibles en position de pliage. Barre avec mécanisme automatique pour blocage et déblocage et pour permettre le pliage du support vertical. Chariot entièrement plié. Occupe peu de place. Tous ses composants sont intégrés pour ne pas les perdre.

Halterungsvorrichtung für die herausnehmbaren Stangen in abgeklappter Position. Stange mit automatischem Mechanismus zum Entriegeln und Zusammenklappen des senkrechten Gestells. Der Wagen lässt sich vollständig zusammenklappen. Platzsparend sind alle Bestandteile integriert, damit sie nicht verloren gehen.



Code Código Code Code	EAN	Name Nombre Nom Name	Units per box Unidades por caja Unités par boîte Stückzahl pro Packung	Packaging size Medidas embalaje Dimensions emballage Verpackungsmaße	Packaging volume Volumen embalaje Volume d'emballage Verpackungsvolumen	Gross weight Peso bruto Poids brut Bruttogewicht	Loading quantity Unidades por contenedor Unités par conteneur Einheiten pro Container
RA-105A	8437009886069	XXL trolley	1	212.7 x 101.6 x 15.2 cm 83.7" x 40" x 6"	0.328 m ³ 11.583 ft ³	37.1 kg 81.6 lb	Container 40': 189 Container 40' HC: 210

XXLmoon

TABLE MESA TABLE TISCH

4-5
 20.7 kg / 45.6 lb
 300 kg / 661 lb
 Water-resistant
 HDPE Light Grey / POWDER-COATED STEEL Grey

Limited 10-year warranty

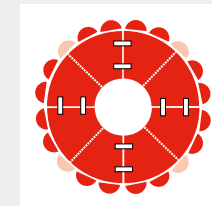
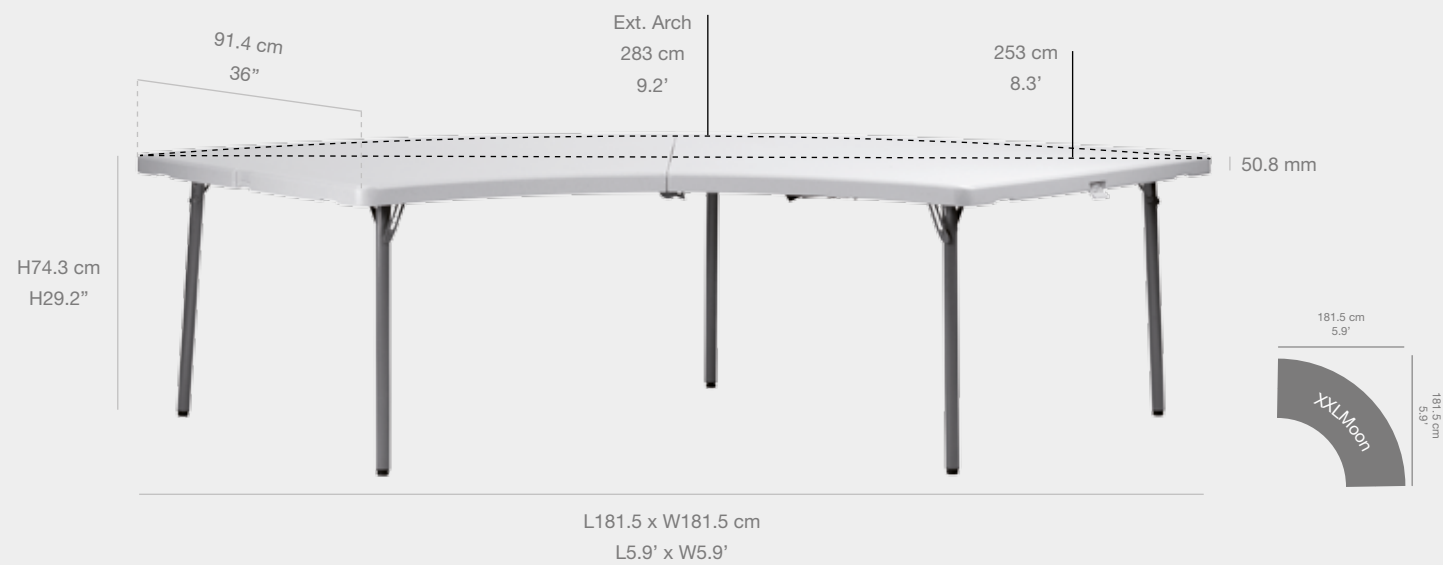

Circular joining of four XXLmoon tables with 1 planet180 table. Capacity for 16 to 20 persons.

Unión circular de 4 mesas XXLmoon con 1 mesa planet180. Capacidad 16 a 20 personas.

Raccord circulaire de 4 tables XXLmoon avec 1 table planet180. Capacité 16 à 20 personnes.

Kreisförmige Verbindung von 4 Tischen XXLmoon mit einem Tisch planet180. Bietet Platz für 16 bis 20 Personen.

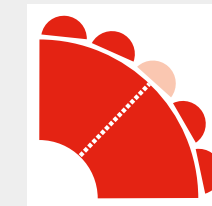

Capacity: 4 or 5 persons. Area per person: 28" or 22.5".

Capacidad: 4 o 5 personas. Espacio por persona: 71 o 57 cm.

Capacité: 4 ou 5 personnes. Espace par personne: 71 ou 57 cm.

Bietet Platz für 4 oder 5 Personen. Platz pro Person: 71 oder 57 cm.

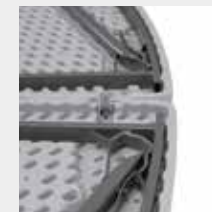

Angular or circular table joining system.

Sistema de unión angular o circular de mesas.

Système de raccord d'angle ou raccord circulaire de tables.

Vorrichtung zur winkel- und kreisförmigen Verbindung von Tischen.



Automatic leg lock when in use.

Bloqueador automático de patas en posición de uso.

Blocage automatique des pieds en position d'usage.

Automatische Feststellung der aufgeklappten Tischbeine.



Height adjusters on 5 legs.

Regulador de altura en las 5 patas.

Régulateur de hauteur sur les 5 pieds.

Integrierte Höhenverstellung in den 5 Tischbeinen.



Folding table top. Table provided with carrying handle.

Sobre plegable. Mesa provista de un asa.

Surface pliable. Table munie d'une anse.

Der zusammengeklappte Tisch hat einen Tragegriff.

the textilecollection

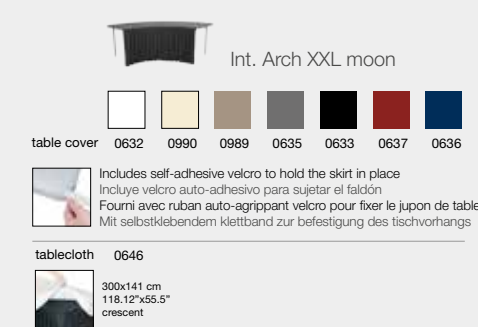
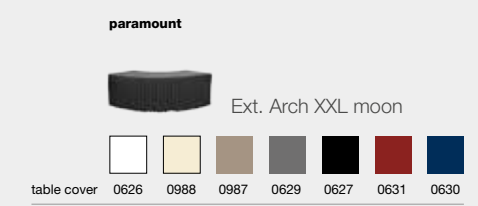
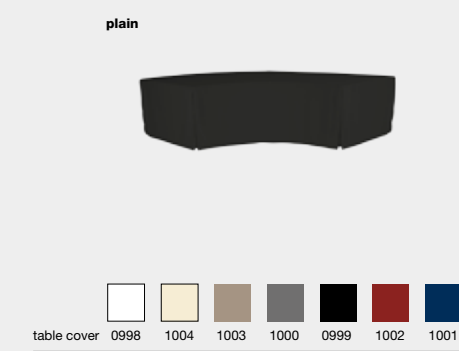
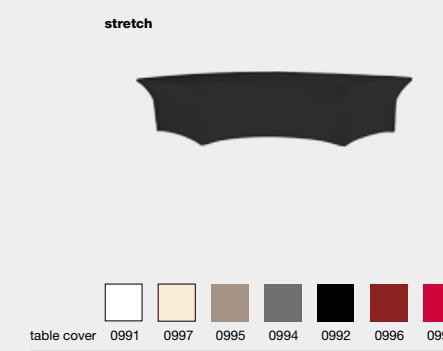

Code Código Code Code	EAN	Name Nombre Nom Name	Units per box Unidades por caja Unités par boîte Stückzahl pro Packung	Packaging size Medidas embalaje Dimensions emballage Verpackungsmaße	Packaging volume Volumen embalaje Volume d'emballage Verpackungsvolumen	Gross weight Peso bruto Poids brut Bruttogewicht	Loading quantity Unidades por contenedor Unités par conteneur Einheiten pro Container
PT-35	8437009886076	XXLmoon	1	142.2 x 101 x 12 cm 56" x 39.7" x 4.7"	0.172 m ³ 6.074 ft ³	24.7 kg 54.34 lb	Container 40': 344 Container 40' HC: 390

Includes self-adhesive velcro to hold the skirt in place
Incluye velcro auto-adhesivo para sujetar el faldón
Fourni avec ruban auto-agrippant velcro pour fixer le jupon de table
Mit selbstklebendem Klettband zur Befestigung des Tischvorhangs



planet120

TABLE MESA TABLE TISCH

Round table for up to six diners.
Mesa redonda para hasta seis comensales.
Table ronde pour six personnes.
Runder Tisch für bis zu sechs Personen.

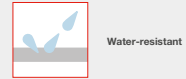

Limited
10-year
warranty

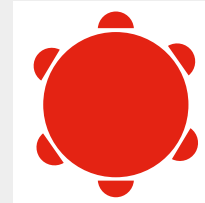

Capacity: 6 persons.
Area per person: 25".

Capacidad: 6 personas.
Espacio por persona: 64 cm.

Capacité: 6 personnes.
Espace par personne: 64 cm.

Bietet Platz für 6 Personen.
Platz pro Person: 64 cm.



ø122 cm
ø4'

Table top "L shape" beam:
W41.5 x H41.5 x TH2.5 mm

Leg crossbar:
ø19.1 x TH1.0 mm



Leg axis:
ø22.2 x TH1.0 mm

Leg tube:
ø28.6 x TH1.0 mm

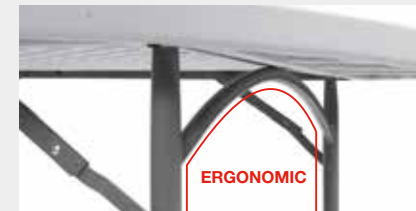

Ergonomic crosspieces for greater comfort.

Travesaños ergonómicos para un mayor confort.

Traverses ergonomiques pour plus de confort.

Ergonomische Quertraverse für mehr Bequemlichkeit.



Manual lock (1) and sliding ring (2) for greater leg stability when in use.

Bloqueador manual (1) y argolla autodeslizante (2) para mayor seguridad de las patas en posición de uso.

Blocage manuel (1) et anneau autoglissant (2) pour plus de sécurité des pieds en position d'usage.

Manuelle Feststellung (1) und selbstgleitender Metallschiebering (2) für eine höhere Sicherheit der Tischbeine in aufgeklappter Position.



Planetrolley available for 16 tables. See page 72.

Carro planetrolley disponible para 16 mesas. Ver pág. 72.

Chariot planetrolley disponible pour 16 tables. Voir page 72.

Wagen planetrolley lieferbar für 16 Tische. Siehe S.72.

thetextilecollection

stretch



paramount



plain

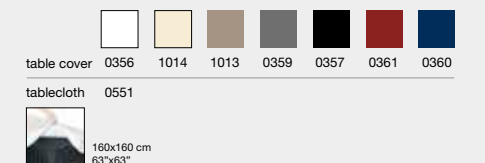
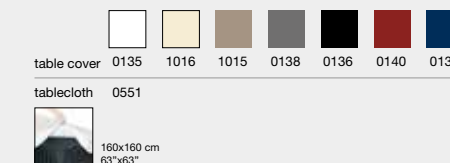
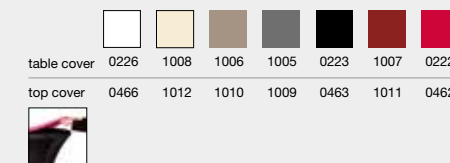

Code Código Code Code	EAN	Name Nombre Nom Name	Units per box Unidades por caja Unités par boîte Stückzahl pro Packung	Packaging size Medidas embalaje Dimensions emballage Verpackungsmaße	Packaging volume Volumen embalaje Volume d'emballage Verpackungsvolumen	Gross weight Peso bruto Poids brut Bruttogewicht	Loading quantity Unidades por contenedor Unités par conteneur Einheiten pro Container
BT-48B	8437009886229	planet120	1	124.5 x 124.5 x 6.4 cm 49" x 49" x 2.5"	0.099 m ³ 3.496 ft ³	14.4 kg 31.68 lb	Container 40': 505 Container 40' HC: 700



planet150

TABLE MESA TABLE TISCH

Round folding table for up to eight diners.
Mesa plegable redonda para hasta ocho comensales.
Table pliante ronde pour huit personnes.
Runder Klapp Tisch für bis zu acht Personen.



Limited 10 year warranty

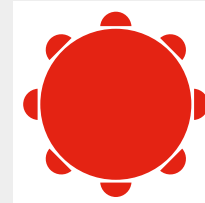

Capacity: 8 persons.
Area per person: 23.5".
Capacidad: 8 personas.
Espacio por persona: 59.7 cm.
Capacité: 8 personnes.
Espace par personne: 59.7 cm.
Bietet Platz für 8 Personen.
Platz pro Person: 59.7 cm.



H74.3 cm
H29.2"

50.8 mm

ø152.4 cm
ø5'

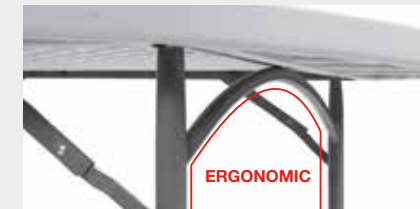

Ergonomic crosspieces for greater comfort.
Travesaños ergonómicos para un mayor confort.
Traverse ergonomiques pour plus de confort.
Ergonomische Quertraverse für mehr Bequemlichkeit.



Manual lock (1) and sliding ring (2) for greater leg stability when in use.
Bloqueador manual (1) y argolla auto-deslizante (2) para mayor seguridad de las patas en posición de uso.
Blocage manuel (1) et anneau autoglisant (2) pour plus de sécurité des pieds en position d'usage.
Manuelle Feststellung (1) und selbstgleitender Metallschieber (2) für eine höhere Sicherheit der Tischbeine in aufgeklappter Position.



Planetrolley available for 14 tables. See page 72.
Carro planetrolley disponible para 14 mesas. Ver pág. 72.
Chariot planetrolley disponible pour 14 tables. Voir page 72.
Wagen planetrolley lieferbar für 14 Tische. Siehe S.72.

thetextilecollection

stretch



paramount



plain



Code Código Code Code	EAN	Name Nombre Nom Name	Units per box Unidades por caja Unités par boîte Stückzahl pro Packung	Packaging size Medidas embalaje Dimensions emballage Verpackungsmaße	Packaging volume Volumen embalaje Volume d'emballage Verpackungsvolumen	Gross weight Peso bruto Poids brut Bruttogewicht	Loading quantity Unidades por contenedor Unités par conteneur Einheiten pro Container
BT-60B	8437009886083	planet150	1	154.9 x 154.9 x 7 cm 61" x 61" x 2.8"	0.168 m ³ 5.932 ft ³	21.86 kg 48.09 lb	Container 40': 320 Container 40' HC: 360

table cover	0233	1020	1018	1017	0230	1019	0229
top cover	0473	1024	1022	1021	0470	1023	0469

table cover	0141	1028	1027	1014	0142	0146	0145
tablecloth	0552						
	190x190 cm 74.8" x 74.8"						

table cover	0362	1026	1025	0365	0363	0367	0366
tablecloth	0552						
	190x190 cm 74.8" x 74.8"						

planet160

TABLE MESA TABLE TISCH

Round folding table for up to eight diners.
Mesa plegable redonda para hasta ocho comensales.
Table pliante ronde pour huit personnes.
Runder Klapp Tisch für bis zu acht Personen.



Limited
10-year
warranty

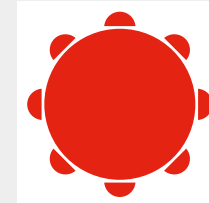

Capacity: 8 persons.
Area per person: 24.7".

Capacidad: 8 personas.
Espacio por persona: 62.8 cm.

Capacité: 8 personnes.
Espace par personne: 62.8 cm.

Bietet Platz für 8 Personen.
Platz pro Person: 62.8 cm.



H74.3 cm
H29.2"

50.8 mm

ø160 cm
ø63"



Tabletop circular beam:
W15 x H30 x TH1.0 mm

Leg tube:
ø31.8 x TH1.0 mm

Leg axis:
ø22.2 x TH1.0 mm

Tabletop crossbeam:
W15 x H30 x TH1.0 mm

Tabletop beam:
W19 x H19 x TH1.0 mm

Leg crossbar:
ø22.2 x TH1.0 mm

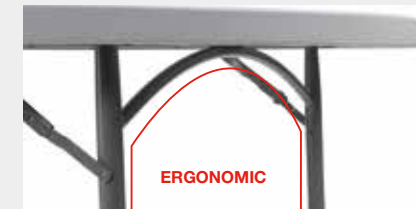

Ergonomic crosspieces for greater comfort.

Travesaños ergonómicos para un mayor confort.

Traverses ergonomiques pour plus de confort.

Ergonomische Quertraverse für mehr Bequemlichkeit.



Manual lock (1) and sliding ring (2) for greater leg stability when in use.

Bloqueador manual (1) y argolla autodeslizante (2) para mayor seguridad de las patas en posición de uso.

Blocage manuel (1) et anneau autoglissant (2) pour plus de sécurité des pieds en position d'usage.

Manuelle Feststellung (1) und selbstgleitender Metallschiebering (2) für eine höhere Sicherheit der Tischbeine in aufgeklappter Position.



Planetrolley available for 14 tables. See page 72.

Carro planetrolley disponible para 14 mesas. Ver pág. 72.

Chariot planetrolley disponible pour 14 tables. Voir page 72.

Wagen planetrolley lieferbar für 14 Tische. Siehe S.72.

thetextilecollection

stretch



paramount



plain

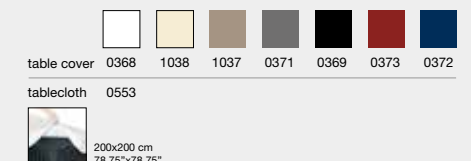
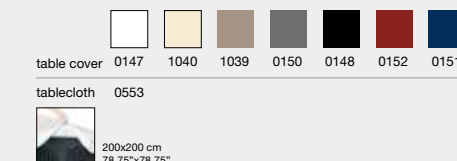
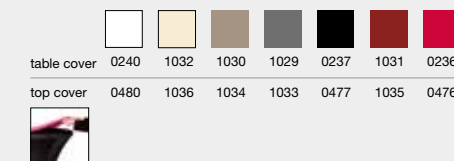

Code Código Code Code	EAN	Name Nombre Nom Name	Units per box Unidades por caja Unités par boîte Stückzahl pro Packung	Packaging size Medidas embalaje Dimensions emballage Verpackungsmaße	Packaging volume Volumen embalaje Volume d'emballage Verpackungsvolumen	Gross weight Peso bruto Poids brut Bruttogewicht	Loading quantity Unidades por contenedor Unités par conteneur Einheiten pro Container
BT-63	8437010781728	planet160	1	163.3 x 162.6 x 7 cm 64.3" x 64" x 2.8"	0.185 m ³ 6.547 ft ³	29.14 kg 64.11 lb	Container 40': 308 Container 40' HC: 336

planet180

TABLE MESA TABLE TISCH

 10

 29.3 kg
64.6 lb

 350 kg
772 lb

 Water-resistant

HDPE
Light Gray
POWDER-COATED
STEEL
Gray

Limited
10-year
warranty



H74.3 cm
H29.2"

55 mm

ø180.3 cm
ø5.92'

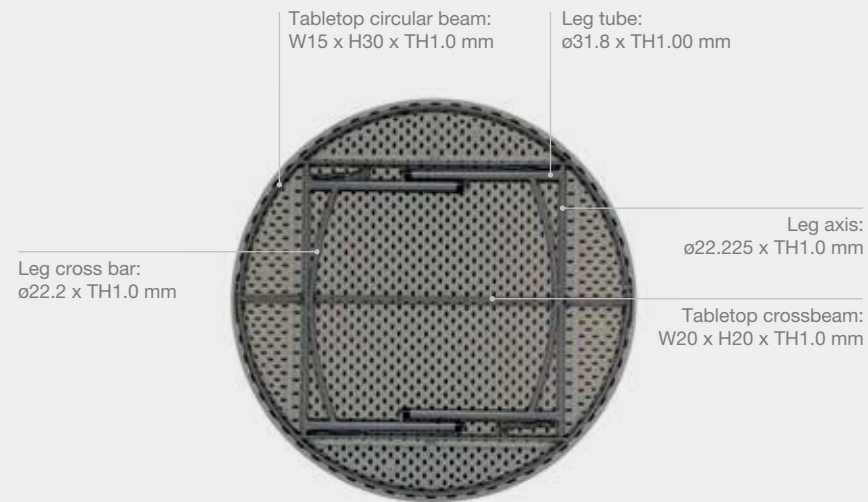

Round folding table for up to ten diners. The XLmoon or XXLmoon tables can be concentrically attached to make configurations for up to 20 diners. Mesa plegable redonda para hasta diez comensales. Se le pueden acoplar concéntricamente mesas XLmoon o XXLmoon para conseguir composiciones de hasta 20 comensales. Table pliante ronde pour dix personnes. Il est possible d'y ajouter des tables XLmoon ou XXLmoon pour créer des compositions pouvant accueillir jusqu'à 20 personnes. Runder Klappstisch für bis zu zehn Personen. Kann konzentrisch mit den Tischen XLmoon oder XXLmoon verbunden werden, um eine Anordnung für bis zu 20 Personen zu erzielen.

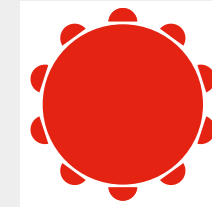

Capacity: 10 persons.
Area per person: 22.3".
Capacidad: 10 personas.
Espacio por persona: 56.6 cm.
Capacité: 10 personnes.
Espace par personne: 56.6 cm.
Bietet Platz für 10 Personen.
Platz pro Person: 56.6 cm.

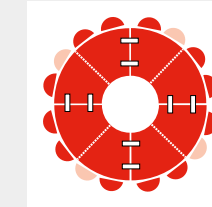

Circular joining of four XLmoon tables with 1 planet180 table. Capacity for 12 to 16 persons.
Unión circular de 4 mesas XLmoon con 1 mesa planet180. Capacidad 12 a 16 personas.
Raccord circulaire de 4 tables XLmoon avec 1 table planet180. Capacité 12 à 16 personnes.
Kreisförmige Verbindung von 4 Tischen XLmoon mit einem Tisch planet180. Bietet Platz für 12 bis 16 Personen.

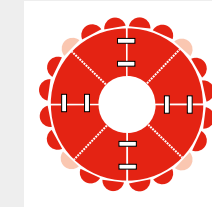

Circular joining of four XXLmoon tables with 1 planet180 table. Capacity for 16 to 20 persons.
Unión circular de 4 mesas XXLmoon con 1 mesa planet180. Capacidad 16 a 20 personas.
Raccord circulaire de 4 tables XXLmoon avec 1 table planet180. Capacité 16 à 20 personnes.
Kreisförmige Verbindung von 4 Tischen XXLmoon mit einem Tisch planet180. Bietet Platz für 16 bis 20 Personen.

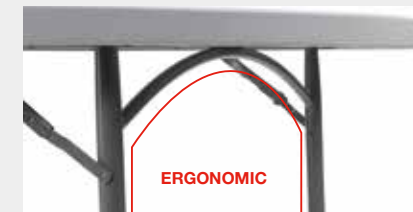

Ergonomic crosspieces for greater comfort.
Travesaños ergonómicos para un mayor confort.
Traverse ergonomiques pour plus de confort.
Ergonomische Quertraverse für mehr Bequemlichkeit.



Manual lock (1) and sliding ring (2) for greater leg stability when in use.
Bloqueador manual (1) y argolla autodeslizante (2) para mayor seguridad de las patas en posición de uso.
Blocage manuel (1) et anneau autoglisant (2) pour plus de sécurité des pieds en position d'usage.
Manuelle Feststellung (1) und selbstgleitender Metallschiebering (2) für eine höhere Sicherheit der Tischbeine in aufgeklappter Position.



Planetrolley available for 13 tables. See page 72.
Carro planetrolley disponible para 13 mesas. Ver pág. 72.
Chariot planetrolley disponible pour 13 tables. Voir page 72.
Wagen planetrolley lieferbar für 13 Tische. Siehe S.72.

thetextilecollection

stretch

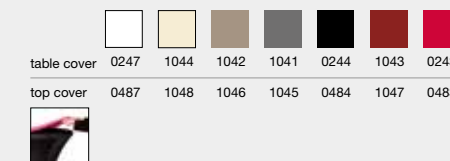

paramount

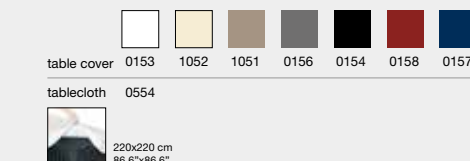

plain

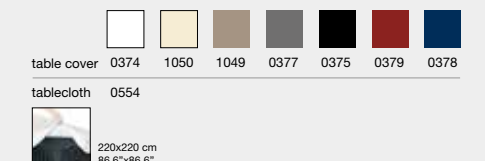

Code Código Code Code	EAN	Name Nombre Nom Name	Units per box Unidades por caja Unités par boîte Stückzahl pro Packung	Packaging size Medidas embalaje Dimensions emballage Verpackungsmaße	Packaging volume Volumen embalaje Volume d'emballage Verpackungsvolumen	Gross weight Peso bruto Poids brut Bruttogewicht	Loading quantity Unidades por contenedor Unités par conteneur Einheiten pro Container
BT-71	8437009886236	planet180	1	183 x 183 x 7.3 cm 72" x 72" x 2.8"	0.243 m ³ 8.581 ft ³	33 kg 72.60 lb	Container 40': 241 Container 40' HC: 265

Trolley with extendable handle suitable for the planet120, planet150, planet160 and planet180 tables.
 Carro con asa extensible apto para las mesas planet120, planet150, planet160 y planet180.
 Chariot avec anse extensible, compatible avec les tables planet120, planet150, planet160 et planet180.
 Wagen mit ausziehbarem Griff, geeignet für die Tische planet120, planet150, planet160 und planet180.

planetrolley

TROLLEY CARRO CHARIOT WAGEN



30.8 kg
67.9 lb



H102 cm
H40.2"

L(132 + 30) x W83.2 cm
L(52" + 11.8") x W32.7"



Extendable handle.
Asa extensible.
Anse extensible.
Ausziehbarer Griff.



Four polyurethane wheels with built-in brake. (Two fixed wheels and two pivoting wheels).
4 ruedas de poliuretano con freno incorporado (2 ruedas fijas y 2 ruedas pivotantes).
4 roulettes en polyuréthane avec frein intégré. (2 roulettes fixes et 2 roulettes pivotantes).
4 PU-Räder mit integrierter Bremse. (2 feststehende Räder und 2 Schwenkräder).



Large loading platform.
Amplia plataforma de apoyo.
Large plateau de support.
Breite Ladefläche.



Polyester strap with tensioning mechanism to hold the tables in an upright position when the trolley is half loaded.

Correa de poliéster con tensor para mantener las mesas verticales si el carro está a media carga.

Courroie en polyester avec tendeur pour le maintien vertical des tables lorsque le chariot est à moitié plein.

Spannriemen aus Polyester zur Befestigung der senkrecht aufgestellten Tische, wenn der Wagen nur halbvoll ist.



Capacity: 16 pcs. Planet120, 14 pcs. Planet150, 14 pcs. Planet160, 13 pcs. Planet180.

Capacidad: 16u. Planet120, 14u. Planet150, 14u. Planet160, 13u. Planet180.

Capacité: 16u. Planet120, 14u. Planet150, 14u. Planet160, 13u. Planet180.

Fassungsvermögen: 16 Stk. Planet120, 14 Stk. Planet150, 14 Stk. Planet160, 13 Stk. Planet180.

Code Código Code Code	EAN	Name Nombre Nom Name	Units per box Unidades por caja Unités par boîte Stückzahl pro Packung	Packaging size Medidas embalaje Dimensions emballage Verpackungsmaße	Packaging volume Volumen embalaje Volume d'emballage Verpackungsvolumen	Gross weight Peso bruto Poids brut Bruttogewicht	Loading quantity Unidades por contenedor Unités par conteneur Einheiten pro Container
RA-106A	8437009886090	planetrolley	1	135.7 x 87.6 x 12.7 cm 53.5" x 34.5" x 5"	0.150 m ³ 5.297 ft ³	34.5 kg 75.9 lb	Container 40': 396 Container 40' HC: 460

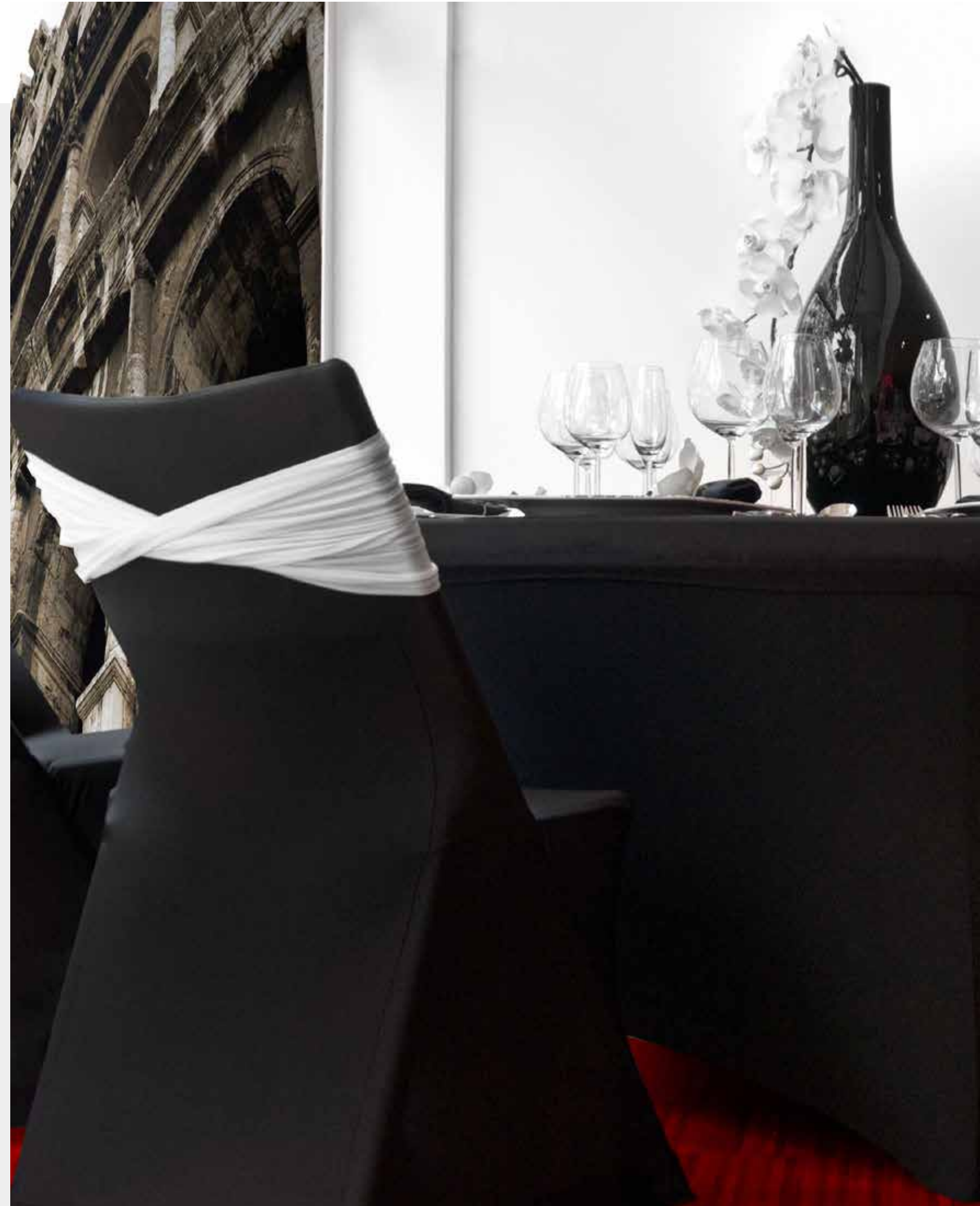

cocktail80

TABLE MESA TABLE TISCH



8.9 kg
18 lb



170 kg
375 lb



Water-resistant



HDPE
Light Grey
POWDER-COATED
STEEL
Grey

Limited 10
year
warranty



U-shaped plate:
ø25.4 x TH1.0 mm

Tabletop crossbeam:
W10 x H20 x TH1.0 mm

Leg tube:
ø25.4 x TH1.0 mm

Tabletop beam:
W10 x H20 x TH1.0 mm

Open-position
blocking device

Leg crossbar:
ø19.1 x TH1.0 mm



High table with automatic leg locking mechanism.
Mesa alta con bloqueador automático de las patas.
Table haute avec système de blocage automatique des pieds.
Hoher Tisch mit automatischer Beinverriegelung.



Light and easy to fold and store.
Ligera y fácil de plegar y guardar.
Légère, facile à plier et à ranger.
Leicht und einfach zusammenzuklappen und zu verstauen.



Large base which provides
great stability.
Base amplia que proporciona
gran estabilidad.
Base large qui confère une
grande stabilité.
Eine breite Standfläche sorgt
für eine ausgezeichnete
Standfestigkeit.



Manual lock for legs when in use.
Bloqueador de las patas en
posición de uso.
Blocage des pieds en position
d'utilisation.
Arretierung für Tischbeine in
aufgeklappter Position.

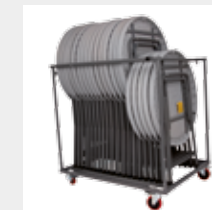

Cocktailtrolley available for 20
tables. See page 82.
Carro Cocktailtrolley disponible
para 20 mesas. Ver pág. 82.
Chariot Cocktailtrolley disponible
pour 20 tables.
Voir page 82. Wagen
Cocktailtrolley lieferbar für 20
Tische. Siehe S.82.

thetextilecollection

stretch



paramount



plain



Code Código Code Code	EAN	Name Nombre Nom Name	Units per box Unidades por caja Unités par boîte Stückzahl pro Packung	Packaging size Medidas embalaje Dimensions emballage Verpackungsmaße	Packaging volume Volumen embalaje Volume d'emballage Verpackungsvolumen	Gross weight Peso bruto Poids brut Bruttogewicht	Loading quantity Unidades por contenedor Unités par conteneur Einheiten pro Container
PT-36	8437009886243	cocktail80	1	141 x 82.9 x 7 cm 55.5" x 32.6" x 2.7"	0.082 m ³ 2.895 ft ³	10.85 kg 23.87 lb	Container 40': 750 Container 40' HC: 870

table cover	0296	1056	1054	1053	0293	1055	0292	0294	0295	0298	0297	table cover	0111	1064	1063	0114	0112	0116	0115	table cover	0326	1062	1061	0329	0327	0331	0330
top cover	0543	1060	1058	1057	0540	1059	0539	0541	0542	0545	0544	tablecloth	0547	tablecloth	0547												
													120x120 cm 47.25" x 47.25"								120x120 cm 47.25" x 47.25"						



7.6 kg
16.8 lb



170 kg
375 lb



Water-resistant



HDPE
Light Grey
POWDER-COATED
STEEL
Grey

Limited
10-year
warranty



U-shaped plate:
ø25.4 x TH1.0 mm

Tabletop crossbeam:
W10 x H20 x TH1.0 mm

Leg tube:
ø25.4 x TH1.0 mm



Tabletop beam:
W10 x H20 x TH1.0 mm

Open-position blocking device:
W10 x H20 x TH1.0 mm

Leg crossbar:
ø19.1 x TH1.0 mm



Large base which provides great stability.
Base amplia que proporciona gran estabilidad.
Base large qui confère une grande stabilité.
Eine breite Standfläche sorgt für eine ausgezeichnete Standfestigkeit.



Light and easy to fold and store.
Ligera y fácil de plegar y guardar.
Légère, facile à plier et à ranger.
Leicht und einfach zusammenzuklappen und zu verstauen.

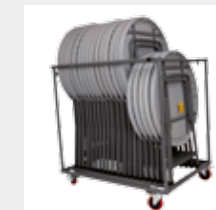

Cocktailtrolley available for 20 tables. See page 82.
Carro Cocktailtrolley disponible para 20 mesas. Ver pág. 82.
Chariot Cocktailtrolley disponible pour 20 tables.
Voir page 82. Wagen Cocktailtrolley lieferbar für 20 Tische. Siehe S.82.



Manual lock for legs when in use.
Bloqueador de las patas en posición de uso.
Blocage des pieds en position d'utilisation.
Arretierung für Tischbeine in aufgeklappter Position.

the textilecollection

stretch



paramount



plain



Code Código Code Code	EAN	Name Nombre Nom Name	Units per box Unidades por caja Unités par boîte Stückzahl pro Packung	Packaging size Medidas embalaje Dimensions emballage Verpackungsmaße	Packaging volume Volumen embalaje Volume d'emballage Verpackungsvolumen	Gross weight Peso bruto Poids brut Bruttogewicht	Loading quantity Unidades por contenedor Unités par conteneur Einheiten pro Container
PT-37	8437009886106	praxis80	1	110.5 x 82.7 x 7 cm 43.5" x 33.6" x 2.7"	0.064 m ³ 2.260 ft ³	9 kg 20 lb	Container 40': 968 Container 40' HC: 1112

table cover	0303	1074	1072	1071	0300	1073	0299
top cover	0543	1060	1058	1057	0540	1059	0539

table cover	0159	1078	1077	0162	0160	0164	0163
tablecloth	0547						
	120x120 cm 47.25" x 47.25"						

table cover	0380	1076	1075	0383	0381	0385	0384
tablecloth	0547						
	120x120 cm 47.25" x 47.25"						

Multipurpose folding square table.
Mesa cuadrada plegable multiusos.
Table carrée pliable multi-usages.
Quadratischer Mehrzweck-Klapptisch.

bistrot70

TABLE MESA TABLE TISCH



2



6.17 kg
13.5 lb



225 kg
500 lb



Water-resistant



HDPE
White
POWDER-COATED
STEEL
White

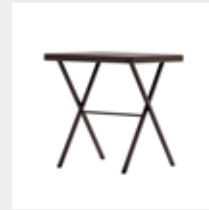

HDPE
Dark Bronze
POWDER-COATED
STEEL
Dark Bronze

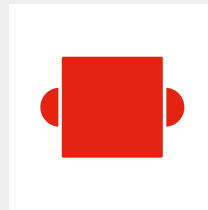

Capacity: 2 persons.
Area per person: 26".
Capacidad: 2 personas.
Espacio por persona: 66 cm.
Capacité: 2 personnes.
Espace par personne: 66 cm.
Bietet Platz für 2 Personen.
Platz pro Person: 66 cm.

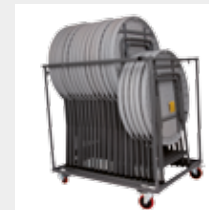

Cocktail trolley available for 20 tables. See page 82.
Carro cocktail trolley disponible para 20 mesas. Ver pág. 82.
Chariot cocktail trolley disponible pour 20 tables. Voir page 82.
Wagen cocktail trolley lieferbar für 20 Tische. Siehe S.82.



Easy to fold, transport and store.
Fácil de plegar, transportar y guardar.
Facile à plier, à transporter et à stocker.
Einfach zusammenzuklappen, zu transportieren und aufzubewahren



Code Código Code Code	EAN	Name Nombre Nom Name	Units per box Unidades por caja Unités par boîte Stückzahl pro Packung	Packaging size Medidas embalaje Dimensions emballage Verpackungsmaße	Packaging volume Volumen embalaje Volume d'emballage Verpackungsvolumen	Gross weight Peso bruto Poids brut Bruttogewicht	Loading quantity Unidades por contenedor Unités par conteneur Einheiten pro Container
BT009X001A-W	8436539299653	bistrot70 white	1	70.20 x 6.03 x 102.9 cm 27.62" x 2.37" x 40.5"	0.044 m ³ 1.412 ft ³	7.67 kg 16.90 lb	Container 40': 1420 Container 40' HC: 1590
BT009X001A-DB	8436539299660	bistrot70 dark bronze					

Special trolley for transporting and storing the Cocktail80 and Praxis80 tables.
 Carro especial para el transporte y almacenaje de las mesas Cocktail80 y Praxis80.
 Chariot spécial pour le transport et le stockage des tables Cocktail80 et Praxis80.
 Spezieller Transport- und Lagerwagen für die Tische Cocktail80 und Praxis80.

cocktailtrolley

TROLLEY CARRO CHARIOT WAGEN



25.5 kg
56.2 lb



H101 cm
H39.6"

L121 x W89 cm
L47.6" x W35"



Base with 4° angle of inclination to keep the tables upright when loaded.

Base con 4° de inclinación para mantener las mesas verticales durante la carga.

Support d'une inclinaison de 4°, servant à tenir les tables à la verticale pendant le chargement.

Auflage mit 4° Neigung, um die Tische beim Laden senkrecht zu halten.



Grooved base to prevent the tables from slipping.

Base dentada para evitar que las mesas resbalen.

Support crénelé servant à empêcher que les tables ne glissent.

Gezackte Auflage, damit die Tische nicht verrutschen können.



Four polyurethane wheels with built-in brake. (Two fixed wheels and two pivoting wheels).

4 ruedas de poliuretano con freno incorporado (2 ruedas fijas y 2 ruedas pivotantes).

4 roulettes en polyuréthane avec frein intégré. (2 roulettes fixes et 2 roulettes pivotantes).

4 PU-Räder mit integrierter Bremse. (2 feststehende Räder und 2 Schwenkräder).



Capacity: 20 units of the cocktail80, praxis80 or bistrot70 tables.

Capacidad: 20 u. mesas cocktail80, praxis80 o bistrot70.

Capacité: 20 unités de tables cocktail80, praxis80 ou bistrot70.

Kapazität: 20 cocktail80, praxis80 - oder bistrot70-Tische.

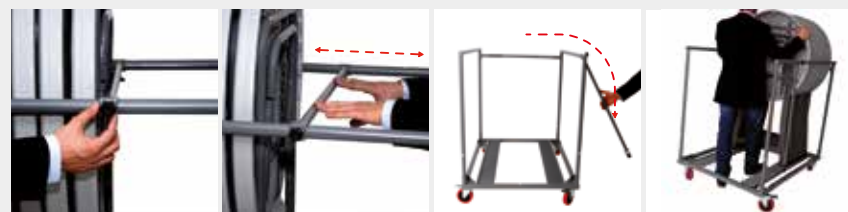

Locking bar which moves along the side rails to fix the tables in position even at half load. The bar revolves around one of the rails to allow access to the back of the trolley, making it easier to load.

Barra bloqueadora que se desliza a lo largo de las barandillas laterales para fijar las mesas incluso a media carga. La barra pivota en una de las barandillas para dejar acceso libre hasta el fondo del carro para facilitar la carga.

Barre bloquante se déplaçant le long des rampes latérales afin de fixer les tables, y compris en demie charge. La barre pivote sur une des rampes afin de laisser accès libre jusqu'au fond du chariot et faciliter ainsi le chargement.

Am Rahmen verschiebbare Sicherungsstange zur Sicherung der Tische auch bei halber Wagenladung. Die Sicherungsstange lässt sich an einer Rahmenseite schwenken. Dadurch wird der Zutritt bis zum hinteren Ende des Wagens ermöglicht und das Auf- und Abladen erleichtert.



Code Código Code Code	EAN	Name Nombre Nom Name	Units per box Unidades por caja Unités par boîte Stückzahl pro Packung	Packaging size Medidas embalaje Dimensions emballage Verpackungsmaße	Packaging volume Volumen embalaje Volume d'emballage Verpackungsvolumen	Gross weight Peso bruto Poids brut Bruttogewicht	Loading quantity Unidades por contenedor Unités par conteneur Einheiten pro Container
RA-277	8437009886809	cocktailtrolley	1	118.3 x 92.7 x 12.7 cm 46.6" x 36.6" x 5"	0.140 m ³ 4.944 ft ³	26.9 kg 59.18 lb	Container 40': 380 Container 40' HC: 420

Bench with folding legs and one-piece top.
 Banco con patas plegables y sobre de una sola pieza.
 Banc avec pieds réglables et partie supérieure en une seule pièce.
 Bank mit Klappfüßen und Tischplatte aus einem Stück.

oktober**175**

BENCH BANCO BANC BANK



3



9.2 kg
20.2 lb



360 kg
800 lb



Water-resistant



POWER-COATED STEEL Grey

Limited
5-year
warranty

Bench with top that folds in half.
 Banco con sobre plegable por la mitad.
 Banc avec partie supérieure pliante par la moitié.
 Bank mit in der Mitte klappbarer Sitzplatte.

sharp**bench**

BENCH BANCO BANC BANK

240



4



11 kg
24.2 lb



400 kg
882 lb



Water-resistant



POWER-COATED STEEL Grey

Limited
5-year
warranty

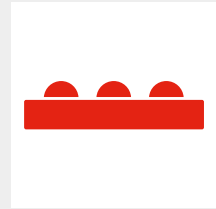

Capacity: 3 persons.
Area per person: 22.8".
Capacidad: 3 personas.
Espacio por persona: 58 cm.
Capacité: 3 personnes.
Espace par personne: 58 cm.
Kapazität: 3 Personen.
Platz pro Person: 58 cm.



One single top piece. With folding legs.
Sobre de una sola pieza. Patas plegables.
Surface d'une seule pièce. Pieds repliables.
Tischplatte aus einem Stück. Klappfüße.



Sliding ring to lock the legs in position when in use. Easy and secure.
Argolla autodeslizante para bloquear las patas en posición de uso. Fácil y seguro.
Anneau autoglisant pour blocage des pieds en position d'usage. Facile et sûr.
Selbstgleitender Metallschiebering zur Feststellung der aufgeklappten Tischbeine. Einfach und sicher.

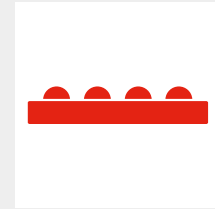

Capacity: 4 persons.
Area per person: 24".
Capacidad: 4 personas.
Espacio por persona: 61 cm.
Capacité: 4 personnes.
Espace par personne: 61 cm.
Bietet Platz für 4 Personen.
Platz pro Person: 61 cm.



Bench with folding top.
Banco con sobre plegable.
Banc avec surface pliable.
Bank mit zusammenklappbarer Sitzfläche.

thetextilecollection

stretch

plain

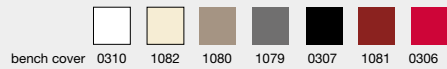

Code Código Code Code	EAN	Name Nombre Nom Name	Units per box Unidades por caja Unités par boîte Stückzahl pro Packung	Packaging size Medidas embalaje Dimensions emballage Verpackungsmaße	Packaging volume Volumen embalaje Volume d'emballage Verpackungsvolumen	Gross weight Peso bruto Poids brut Bruttogewicht	Loading quantity Unidades por contenedor Unités par conteneur Einheiten pro Container
PC-10	8437010781131	oktober 175	1	177 x 31.4 x 8.6 cm 69.7" x 12.4" x 3.4"	0.047 m ³ 1.659 ft ³	10.5 kg 23.10 lb	Container 40': 1320 Container 40' HC: 1500

Code Código Code Code	EAN	Name Nombre Nom Name	Units per box Unidades por caja Unités par boîte Stückzahl pro Packung	Packaging size Medidas embalaje Dimensions emballage Verpackungsmaße	Packaging volume Volumen embalaje Volume d'emballage Verpackungsvolumen	Gross weight Peso bruto Poids brut Bruttogewicht	Loading quantity Unidades por contenedor Unités par conteneur Einheiten pro Container
PC-13G	8436539290568	sharp bench240	1	124.5 x 32.1 x 17.5 cm 49" x 12.6" x 6.9"	0.069 m ³ 2.457 ft ³	12.59 kg 27.70 lb	Container 40': 857 Container 40' HC: 988

Bench with top that folds in half and carrying handle.
 Banco con sobre plegable por la mitad y asa para su transporte.
 Banc avec partie supérieure pliante par la moitié, et anse de transport.
 Bank mit in der Mitte klappbarer Sitzplatte und Tragegriff.

sharpbench

BENCH BANCO BANC BANK



8.1 kg
17.8 lb

400 kg
882 lb



HDPE
Light Grey
POWDER-COATED
STEEL
Grey

Limited
5-year
warranty

Table with top that folds in half and carrying handle.
 Mesa con sobre plegable por la mitad y asa para su transporte.
 Table avec partie supérieure pliante par la moitié, et anse de transport.
 Tisch mit in der Mitte klappbarer Tischplatte und Tragegriff.

sharptable

TABLE MESA TABLE TISCH



13.3 kg
29.3 lb

315 kg
694 lb



HDPE
Light Grey
POWDER-COATED
STEEL
Grey

Limited
10-year
warranty

H44.3 cm
H17.5"



L184 x W30.5 cm
L6' x W12"

48 mm



H74.3 cm
H29.2"



L182.9 x W75.2 cm
L6' x W29.6"

45 mm

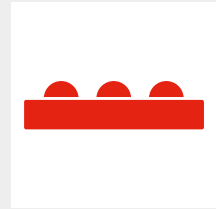
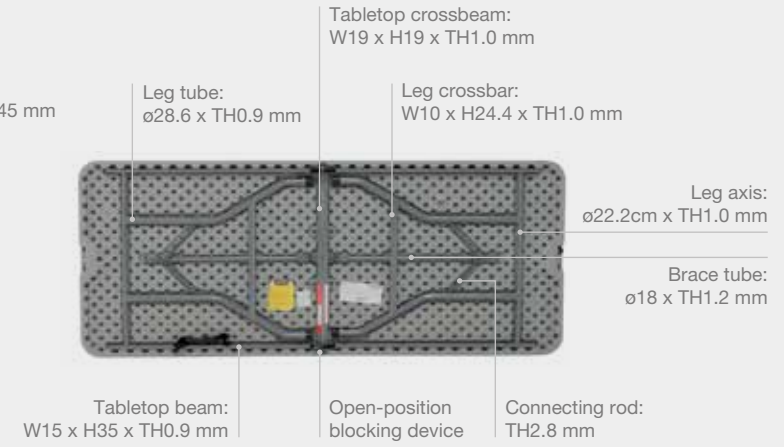

Capacity: 3 persons.
Area per person: 24".
 Capacidad: 3 personas.
Espacio por persona: 61 cm.
 Capacité: 3 personnes.
Espace par personne: 61 cm.
 Bietet Platz für 3 Personen.
Platz pro Person: 61 cm.



Bench with folding top.
 Banco con sobre plegable.
 Banc avec surface pliable.
 Bank mit zusammenklappbarer Sitzfläche.



Bench provided with carrying handle for ease of transport.
 Banco provisto de un asa para su fácil desplazamiento.
 Banc muni d'une anse pour déplacement facile.
 Die Bank ist zur Vereinfachung des Transports mit einem Tragegriff für ausgestattet.



Sliding ring to lock the legs in position when in use. Easy and secure.
 Argolla autodeslizante para bloquear las patas en posición de uso. Fácil y seguro.
 Anneau autoglissant pour blocage des pieds en position d'usage. Facile et sûr.
 Selbstgleitender Metallschieber zur Feststellung der aufgeklappten Tischbeine. Einfach und sicher.

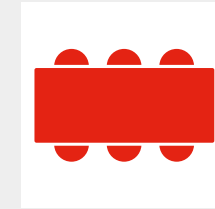

Capacity: 6 persons.
Area per person: 24".
 Capacidad: 6 personas.
Espacio por persona: 61 cm.
 Capacité: 6 personnes.
Espace par personne: 61 cm.
 Bietet Platz für 6 Personen.
Platz pro Person: 61 cm.

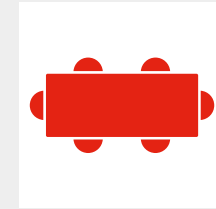

Capacity: 6 persons.
Area per person: 24".
 Capacidad: 6 personas.
Espacio por persona: 61 cm.
 Capacité: 6 personnes.
Espace par personne: 61 cm.
 Bietet Platz für 6 Personen.
Platz pro Person: 61 cm.



Folding table top.
 Sobre plegable.
 Surface pliable.
 Zusammenklappbare Tischplatte.



Table provided with carrying handle for ease of transport.
 Mesa provista de un asa para su fácil desplazamiento.
 Table munie d'une anse pour déplacement facile.
 Tisch hat einen Griff für den einfachen Transport.



Sliding ring to lock the legs in position when in use. Easy and secure.
 Argolla autodeslizante para bloquear las patas en posición de uso. Fácil y seguro.
 Anneau autoglissant pour blocage des pieds en position d'usage. Facile et sûr.
 Selbstgleitender Metallschieber zur Feststellung der aufgeklappten Tischbeine. Einfach und sicher.

thetextilecollection

stretch

plain



bench cover 0317 1088 1086 1085 0314 1087 0313

bench cover 0386 1090 1089 0389 0387 0391 0390

thetextilecollection

stretch

paramount

plain



table cover 0261 0876 0874 0873 0258 0875 0257
 top cover 0508 0880 0878 0877 0505 0879 0504

table cover 0171 0884 0883 0174 0172 0176 0175
 tablecloth 0556

table cover 0404 0882 0881 0407 0405 0409 0408
 tablecloth 0556



Code Código Code Code	EAN	Name Nombre Nom Name	Units per box Unidades por caja Unités par boîte Stückzahl pro Packung	Packaging size Medidas embalaje Dimensions emballage Verpackungsmaße	Packaging volume Volumen embalaje Volume d'emballage Verpackungsvolumen	Gross weight Peso bruto Poids brut Bruttogewicht	Loading quantity Unidades por contenedor Unités par conteneur Einheiten pro Container
PC-15F	8437009886113	sharp bench180	1	95 x 33 x 11 cm 37.5" x 13" x 4.5"	0.031 m ³ 1.115 ft ³	8.76 kg 19.27 lb	Container 40': 1720 Container 40' HC: 1960

Code Código Code Code	EAN	Name Nombre Nom Name	Units per box Unidades por caja Unités par boîte Stückzahl pro Packung	Packaging size Medidas embalaje Dimensions emballage Verpackungsmaße	Packaging volume Volumen embalaje Volume d'emballage Verpackungsvolumen	Gross weight Peso bruto Poids brut Bruttogewicht	Loading quantity Unidades por contenedor Unités par conteneur Einheiten pro Container
BT-06FG	8437009886250	sharp table	1	77 x 95.5 x 10.5 cm 30.3" x 37.6" x 4.1"	0.077 m ³ 2.719 ft ³	15.8 kg 34.76 lb	Container 40': 810 Container 40' HC: 910

munich50

TABLE MESA TABLE TISCH

Beer table with special leg structure for soft and uneven ground.
Mesa cervecería con estructura de patas especial para suelos blandos e irregulares.
Table brasserie avec une structure de pieds spécialement conçue pour les sols mous et irréguliers.
Bierstisch mit speziellem Fußgestell für weiche und unregelmäßige Böden.



H77 cm
H30.3"

L220 x W50 cm
L86.6" x W19.6"

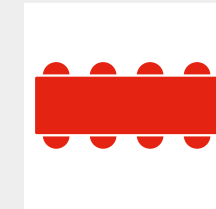
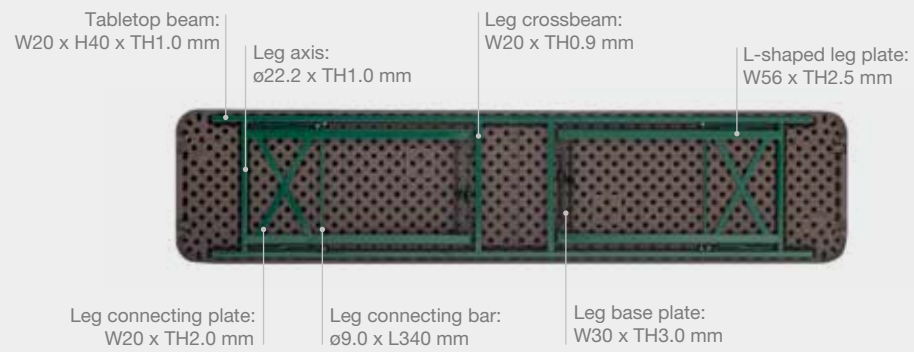

Capacity: 8 persons.
Area per person: 21.7".
Capacidad: 8 personas.
Espacio por persona: 55 cm.
Capacité: 8 personnes.
Espace par personne: 55 cm.
Bietet Platz für 8 Personen.
Platz pro Person: 55 cm.

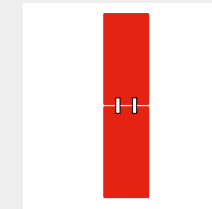

Longitudinal table joining system.
Sistema de unión longitudinal de mesas.
Système de raccord longitudinal de tables.
Vorrichtung zur längsseitigen Verbindung der Tische.



Longitudinal table joining system.
Sistema de unión longitudinal de mesas.
Système de raccord longitudinal de tables.
Vorrichtung zur längsseitigen Verbindung der Tische.



Base frame suitable for soft ground.
Base de apoyo apta para suelos blandos.
Base d'appui apte pour des sols meubles.
Beinrahmen für weiche Böden.



Manual lock (1) and sliding ring (2) for greater leg stability when in use.
Bloqueador manual (1) y argolla autodeslizante (2) para mayor seguridad de las patas en posición de uso.
Blocage manuel (1) et anneau autoglissant (2) pour plus de sécurité des pieds en position d'usage.
Manuelle Feststellung (1) und selbstgleitender Metallschieber (2) für eine höhere Sicherheit der Tischbeine in aufgeklappter Position.



Base with anti-scratch polypropylene foot caps.
Base con tacos anti-rayas de polipropileno.
Base avec talons anti-rayures de polypropylène.
Mit integrierten Bodenschonern.

the textile collection

stretch



table cover 1158 1157 1155 1154 1159 1156 1160

bridge



table cover 1161 1167 1166 1163 1162 1165 1164

Code Código Code Code	EAN	Name Nombre Nom Name	Units per box Unidades por caja Unités par boîte Stückzahl pro Packung	Packaging size Medidas embalaje Dimensions emballage Verpackungsmaße	Packaging volume Volumen embalaje Volume d'emballage Verpackungsvolumen	Gross weight Peso bruto Poids brut Bruttogewicht	Loading quantity Unidades por contenedor Unités par conteneur Einheiten pro Container
PT004X002A	8436539299585	munich50	1	51.75 x 7 x 222.5 cm 20.37" x 2.75" x 87.62"	0.081 m ³ 2.860 ft ³	17.83 kg 39.31 lb	Container 40': 760 Container 40' HC: 850

Beer table with special leg structure for soft and uneven ground.
 Mesa cervecera con estructura de patas especial para suelos blandos e irregulares.
 Table brasserie avec une structure de pieds spécialement conçue pour les sols mous et irréguliers.
 Bierbank mit speziellem Fußgestell für weiche und unregelmäßige Böden.

munich70

TABLE MESA TABLE TISCH



8



18.3 kg
40.3 lb



350 kg
770 lb



Water-resistant



POWDER-COATED STEEL Green



H77 cm
H30.3"



L220 x W67 cm
L86.6" x W26.4"

Beer table with special leg structure for soft and uneven ground.
 Banco cervecero con estructura de patas especial para suelos blandos e irregulares.
 Banc brasserie avec une structure de pieds spécialement conçue pour les sols mous et irréguliers.
 Bierbank mit speziellem Fußgestell für weiche und unregelmäßige Böden.

munichbench

BENCH BANCO BANC BANK



4



13.3 kg
29.9 lb



400 kg
880 lb



Water-resistant



POWDER-COATED STEEL Green



H48 cm
H18.9"

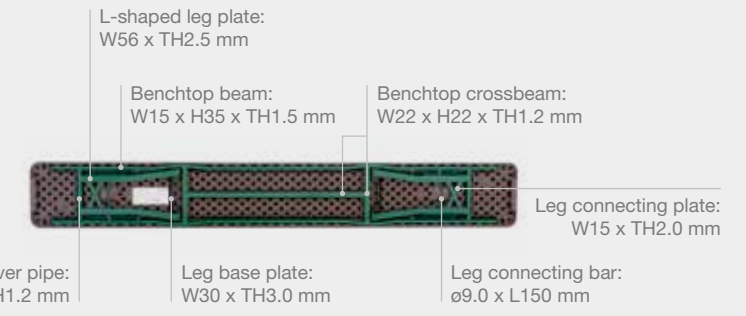

L220 x W30 cm
L86.6" x W11.8"

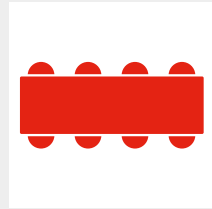

Capacity: 8 persons.
Area per person: 21.7".
Capacidad: 8 personas.
Espacio por persona: 55 cm.
Capacité: 8 personnes.
Espace par personne: 55 cm.
Bietet Platz für 8 Personen.
Platz pro Person: 55 cm.

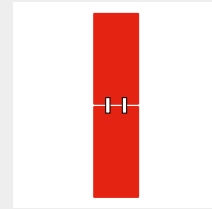

Longitudinal table joining system.
Sistema de unión longitudinal de mesas.
Système de raccord longitudinal de tables.
Vorrichtung zur längsseitigen Verbindung der Tische.



Longitudinal table joining system.
Sistema de unión longitudinal de mesas.
Système de raccord longitudinal de tables.
Vorrichtung zur längsseitigen Verbindung der Tische.



Base frame suitable for soft ground.
Base de apoyo apta para suelos blandos.
Base d'appui apte pour des sols meublés.
Beinrahmen für weiche Böden.



Manual lock (1) and sliding ring (2) for greater leg stability when in use.
Bloqueador manual (1) y argolla autodeslizante (2) para mayor seguridad de las patas en posición de uso.
Blocage manuel (1) et anneau autoglissant (2) pour plus de sécurité des pieds en position d'usage.
Manuelle Feststellung (1) und selbstgleitender Metallschiebering (2) für eine höhere Sicherheit der Tischbeine in aufgeklappter Position.



Base with anti-scratch polypropylene foot caps.
Base con tacos anti-rayas de polipropileno.
Base avec talons anti-rayures de polypropylène.
Mit integrierten Bodenschonern.

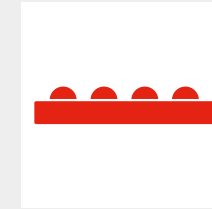

Capacity: 4 persons.
Area per person: 21.7".
Capacidad: 4 personas.
Espacio por persona: 55 cm.
Capacité: 4 personnes.
Espace par personne: 55 cm.
Bietet Platz für 4 Personen.
Platz pro Person: 55 cm.



Base frame suitable for soft ground.
Base de apoyo apta para suelos blandos.
Base d'appui apte pour des sols meublés.
Beinrahmen für weiche Böden.



Manual lock (1) and sliding ring (2) for greater leg stability when in use.
Bloqueador manual (1) y argolla autodeslizante (2) para mayor seguridad de las patas en posición de uso.
Blocage manuel (1) et anneau autoglissant (2) pour plus de sécurité des pieds en position d'usage.
Manuelle Feststellung (1) und selbstgleitender Metallschiebering (2) für eine höhere Sicherheit der Tischbeine in aufgeklappter Position.



Base with anti-scratch polypropylene foot caps.
Base con tacos anti-rayas de polipropileno.
Base avec talons anti-rayures de polypropylène.
Mit integrierten Bodenschonern.

thetextilecollection

stretch

bridge



set cover 0096 1094 1092 1091 0093 1093 0092



set cover 0099 1096 1095 0102 0100 0104 0103

Code Código Code Code	EAN	Name Nombre Nom Name	Units per box Unidades por caja Unités par boîte Stückzahl pro Packung	Packaging size Medidas embalaje Dimensions emballage Verpackungsmaße	Packaging volume Volumen embalaje Volume d'emballage Verpackungsvolumen	Gross weight Peso bruto Poids brut Bruttogewicht	Loading quantity Unidades por contenedor Unités par conteneur Einheiten pro Container
PT-46	8436539290285	munich70	1	222 x 69 x 7 cm 87.6" x 27.1" x 2.7"	0.107 m ³ 3.778 ft ³	20 kg 44 lb	Container 40': 570 Container 40' HC: 645

Code Código Code Code	EAN	Name Nombre Nom Name	Units per box Unidades por caja Unités par boîte Stückzahl pro Packung	Packaging size Medidas embalaje Dimensions emballage Verpackungsmaße	Packaging volume Volumen embalaje Volume d'emballage Verpackungsvolumen	Gross weight Peso bruto Poids brut Bruttogewicht	Loading quantity Unidades por contenedor Unités par conteneur Einheiten pro Container
PC-27	8436539290278	munichbench	1	222 x 32 x 6.9 cm 87.6" x 12.6" x 2.7"	0.049 m ³ 1.730 ft ³	15.2 kg 33.44 lb	Container 40': 1221 Container 40' HC: 1396

Stainless steel bench with optional wheels.
 Banco de trabajo de acero inoxidable con ruedas opcionales.
 Banc de travail en acier inoxydable, avec roulettes en option.
 Arbeitsbank aus Edelstahl mit optionalen Rädern.

SS60

TABLE MESA TABLE TISCH



11.6 kg
25.57 lb



Water-resistant



SS304



H89 cm
H35"

L61 x W61 cm
L24" x W24"



Height adjuster on the 4 legs.
 Regulador de altura en las 4 patas.
 Niveau réglable des 4 pieds.
 Integrierte Höhenverstellung an den 4 Tischbeinen.



Set of four wheels available (two of which have a built-in brake). By adding the wheels, it can also serve the function of a "mobile work table" or "trolley".
 Set de cuatro ruedas disponible (dos de ellas con freno incorporado). Al incorporar las ruedas, puede cumplir también la función de "mesa de trabajo móvil" o de "carro".
 Set de quatre roues disponible (deux d'entre elles avec frein incorporé). L'incorporation des quatre roues permet d'assurer aussi la fonction de "table de travail mobile" ou de "chariot".
 Räder-Set mit vier Rädern lieferbar (zwei davon mit eingebauter Bremse). Durch den Einbau der Räder kann der Tisch auch als "fahrbare Arbeitstisch" oder "Wagen" eingesetzt werden.



Tabletop beam plate:
SS#304, TH 0.7 mm

Shelf plate:
SS#304, TH 0.7 mm

Tabletop:
SS#304, TH 0.7 mm

Leg tube: SS#304,
size: ø42 x TH1.5 mm,
with level adjusters

Stainless steel bench with optional wheels.
 Banco de trabajo de acero inoxidable con ruedas opcionales.
 Banc de travail en acier inoxydable, avec roulettes en option.
 Arbeitsbank aus Edelstahl mit optionalen Rädern.

SS120

TABLE MESA TABLE TISCH



20.2 kg
44.53 lb



Water-resistant



SS304



H89 cm
H35"

L122 x W61 cm
L48" x W24"



Height adjuster on the 4 legs.
 Regulador de altura en las 4 patas.
 Niveau réglable des 4 pieds.
 Integrierte Höhenverstellung an den 4 Tischbeinen.



Set of four wheels available (two of which have a built-in brake). By adding the wheels, it can also serve the function of a "mobile work table" or "trolley".
 Set de cuatro ruedas disponible (dos de ellas con freno incorporado). Al incorporar las ruedas, puede cumplir también la función de "mesa de trabajo móvil" o de "carro".
 Set de quatre roues disponible (deux d'entre elles avec frein incorporé). L'incorporation des quatre roues permet d'assurer aussi la fonction de "table de travail mobile" ou de "chariot".
 Räder-Set mit vier Rädern lieferbar (zwei davon mit eingebauter Bremse). Durch den Einbau der Räder kann der Tisch auch als "fahrbare Arbeitstisch" oder "Wagen" eingesetzt werden.



Tabletop beam plate:
SS#304, TH1.0 x W161.5 mm

Shelf plate:
SS#304, TH1.0 x W526.2 mm

Tabletop beam plate:
SS#304, TH1.0 x W171 mm

Tabletop plate:
SS#304, TH1.0 x W717 mm

Legs: SS#304,
size: ø42, TH1.5 mm,
with level adjusters

Code Código Code Code	EAN	Name Nombre Nom Name	Units per box Unidades por caja Unités par boîte Stückzahl pro Packung	Packaging size Medidas embalaje Dimensions emballage Verpackungsmaße	Packaging volume Volumen embalaje Volume d'emballage Verpackungsvolumen	Gross weight Peso bruto Poids brut Bruttogewicht	Loading quantity Unidades por contenedor Unités par conteneur Einheiten pro Container
OT002X001	8436539296485	SS60 table	Carton A Carton B	62.9 x 64.5 x 12.4 cm 24.7" x 25.4" x 4.9" 19 x 5.7 x 89 cm 7.5" x 2.3" x 35"	0.120 m ³ 4.237 ft ³	13.4 kg 29.54 lb	Container 40': 760 Container 40' HC: 876
107DG006A004A	8436539296492	SSwheels set	1	20 x 20 x 20 cm 7.9" x 7.9" x 7.9"	0.008 m ³ 0.282 ft ³		Container 40': 4300 Container 40' HC: 8700

Code Código Code Code	EAN	Name Nombre Nom Name	Units per box Unidades por caja Unités par boîte Stückzahl pro Packung	Packaging size Medidas embalaje Dimensions emballage Verpackungsmaße	Packaging volume Volumen embalaje Volume d'emballage Verpackungsvolumen	Gross weight Peso bruto Poids brut Bruttogewicht	Loading quantity Unidades por contenedor Unités par conteneur Einheiten pro Container
OT001X001	8436539296416	SS120 table	1	128.3 x 67.3 x 14 cm 50.5" x 26.5" x 5.5"	0.120 m ³ 4.237 ft ³	21.55 kg 47.5 lb	Container 40': 575 Container 40' HC: 651
107DG006A004A	8436539296492	SSwheels set	1	20 x 20 x 20 cm 7.9" x 7.9" x 7.9"	0.008 m ³ 0.282 ft ³		Container 40': 4300 Container 40' HC: 8700

M183

TABLE MESA TABLE TISCH

183x46xh74 cm
72"x18.1"xh29.1"

Pg28



oxford180

TABLE MESA TABLE TISCH

180x50xh74.3 cm
5.9"x19.7"xh29.3"

Pg29



L120

TABLE MESA TABLE TISCH

121.9x61xh74.3 cm
4"x24"xh29.2"

Pg30



XXLtrolley

TROLLEY CARRO CHARIOT WAGEN

(202+46)x92xh115 cm
(79.6"+18.1")x36.2"xh45.3"

Pg58



XXLmoon

TABLE MESA TABLE TISCH

181.5x181.5xh74.3 cm
5.9"x5.9"xh29.2"

Pg60



XXLcorner

TABLE MESA TABLE TISCH

91.4x91.4xh74.3 cm
3'x3"xh29.2"

Pg56



Ltrolley

TROLLEY CARRO CHARIOT WAGEN

131.7x62xh115 cm
51.9"x24.4"xh45.3"

Pg31



XL150

TABLE MESA TABLE TISCH

152.4x76.2xh74.3 cm
5'x30"xh29.2"

Pg34



XL180

TABLE MESA TABLE TISCH

182.9x75.2xh74.3 cm
6'x29.6"xh29.2"

Pg36



SS60

TABLE MESA TABLE TISCH

61x61xh89 cm
24"x24"xh35"

Pg92



SS120

TABLE MESA TABLE TISCH

122x61xh89 cm
48"x24"xh35"

Pg93



buffettablebase

TABLE MESA TABLE TISCH

183.3x75.2xh74 cm
72.1"x29.6"xh29.1"

Pg40



worktop180

TABLE MESA TABLE TISCH

182.9x75.2xh74.3/85.1/90.2/94.3 cm
6'x30"xh29.6"/33.5"/35.5"/37.1"

Pg38



XL240

TABLE MESA TABLE TISCH

243.8x76.2xh74.3 cm
8'x30"xh29.2"

Pg42



XLtrolley

TROLLEY CARRO CHARIOT WAGEN

(193+61)x77xh115 cm
(76"+24")x30.3"x h45.3"

Pg44



planet120

TABLE MESA TABLE TISCH

Ø122xh74.3 cm
Ø4'xh29.2"

Pg64



planet150

TABLE MESA TABLE TISCH

Ø152.4xh74.3 cm
Ø5'xh29.2"

Pg66



planet160

TABLE MESA TABLE TISCH

Ø160xh74.3 cm
Ø63'xh29.2"

Pg68



XLcorner

TABLE MESA TABLE TISCH

75.1x75.1xh74.3 cm
29.56"x29.56"xh29.2"

Pg48



XLmoon

TABLE MESA TABLE TISCH

166.3x166.3xh74.3 cm
5.4'x5.4'xh29.2"

Pg46



topshelf180

SHELF ESTANTE SHELF SHELF

184x30.5xh31 cm
6'x12"xh12.2"

Pg41



planet180

TABLE MESA TABLE TISCH

Ø180.3xh74.3 cm
Ø5.92'xh29.2"

Pg70



planetrolley

TROLLEY CARRO CHARIOT WAGEN

(132+30)x83.2xh102 cm
(52"+11.8")x32.7"xh40.2"

Pg72



cocktail80

TABLE MESA TABLE TISCH

Ø81.3xh110 cm
Ø32"xh43.3"

Pg74



XXL90

TABLE MESA TABLE TISCH

91.4x91.4xh74.3 cm
36"x36"xh29.2"

Pg50



XXL200

TABLE MESA TABLE TISCH

198.2x91.4xh74.3 cm
6.5'x36"xh29.2"

Pg52



XXL240

TABLE MESA TABLE TISCH

240x91.4xh74.3 cm
8'x36"xh29.2"

Pg54



praxis80

TABLE MESA TABLE TISCH

Ø81.3xh74.3 cm
Ø32"xh29.2"

Pg78



bistrot70

TABLE MESA TABLE TISCH

68.6x68.6xh74.3 cm
27"x27"xh29.5"

Pg80



cocktailrolley

TROLLEY CARRO CHARIOT WAGEN

121x89xh101 cm
47.6"x35"xh39.6"

Pg82



sharp**table**

TABLE **MESA** TABLE **TISCH**

182.9x76.2xh75.2 cm
6'x30"xh29.6"

Pg87



sharp**bench180**

BENCH **BANCO** BANC **BANK**

184x30.5xh44.5 cm
6'x12"xh17.5"

Pg86



sharp**bench240**

BENCH **BANCO** BANC **BANK**

244.5x29.4xh44.2 cm
96.26"x11.5"xh17.4"

Pg85



munich**70**

TABLE **MESA** TABLE **TISCH**

220x67xh77 cm
86.6"x26.4"xh30.3"

Pg90



munich**50**

TABLE **MESA** TABLE **TISCH**

220x50xh77 cm
86.6"x19.7"xh30.3"

Pg88



munich**bench**

BENCH **BANCO** BANC **BANK**

220x30xh48 cm
86.6"x11.8"xh18.9"

Pg91



otto**chair**

CHAIR **SILLA** CHAISE **STUHL**

47x54xh84.8 cm
18.5"x21.26"xh33.38"

Pg110



ottotrolley

TROLLEY **CARRO** CHARIOT **WAGEN**

110x47.7xh190 cm
43.3"x18.8"xh74.8"

Pg111



display**rack**

DISPLAY RACK **EXPOSITOR** SUPPORT
D'EXPOSITION **AUSSTELLUNGSTÄNDER**

64.1x61xh71.1cm
25.2"x24"xh28"

Pg121



oktober**175**

BENCH **BANCO** BANC **BANK**

175.3x29.2xh46.4 cm
69"x11.5"xh18.3"

Pg84



norman**trolley**

TROLLEY **CARRO** CHARIOT **WAGEN**

110x48xh190 cm
43.3"x18.9"xh74.8"

Pg113



PARTIAL TABLE SKIRT

Code	Product name	Suitable for the furniture	Use	Shape	Colour	GTIN-13	GTIN-14	Pcs. per bag	Bags per carton	G. per bag	Lb. per bag	GW per carton (kg)	GW per carton (lb)	Polybag size cm	L bag	W bag	H bag	Polybag size in	L bag	W bag	H bag	Carton size cm	L carton	W carton	H carton	Carton size in	L carton	W carton	H carton
SPTT-00566	paramount partial 150 table skirt	L152 x H74.3 cm L5' x H29.2"	table skirt	paramount	white	8436539291961	18436539291968	1	12	800	1.76	10.8	23.76	87	40	3	34.3	15.7	1.2	80	50	15	31.5	19.7	5.9				
SPTT-00567	paramount partial 150 table skirt	L152 x H74.3 cm L5' x H29.2"	table skirt	paramount	black	8436539291978	18436539291975	1	12	800	1.76	10.8	23.76	87	40	3	34.3	15.7	1.2	80	50	15	31.5	19.7	5.9				
SPTT-00569	paramount partial 150 table skirt	L152 x H74.3 cm L5' x H29.2"	table skirt	paramount	anthracite	8436539295884	18436539295881	1	12	800	1.76	10.8	23.76	87	40	3	34.3	15.7	1.2	80	50	15	31.5	19.7	5.9				
SPTT-00570	paramount partial 150 table skirt	L152 x H74.3 cm L5' x H29.2"	table skirt	paramount	blue	8436539295891	18436539295898	1	12	800	1.76	10.8	23.76	87	40	3	34.3	15.7	1.2	80	50	15	31.5	19.7	5.9				
SPTT-00571	paramount partial 150 table skirt	L152 x H74.3 cm L5' x H29.2"	table skirt	paramount	burgundy	8436539295907	18436539295904	1	12	800	1.76	10.8	23.76	87	40	3	34.3	15.7	1.2	80	50	15	31.5	19.7	5.9				
SPTT-01180	paramount partial 150 table skirt	L152 x H74.3 cm L5' x H29.2"	table skirt	paramount	sand	8436539303176	18436539303173	1	12	800	1.76	10.8	23.76	87	40	3	34.3	15.7	1.2	80	50	15	31.5	19.7	5.9				
SPTT-01181	paramount partial 150 table skirt	L152 x H74.3 cm L5' x H29.2"	table skirt	paramount	ecru	8436539303183	18436539303180	1	12	800	1.76	10.8	23.76	87	40	3	34.3	15.7	1.2	80	50	15	31.5	19.7	5.9				
SPTT-00572	paramount partial 180 table skirt	L183 x H74.3 cm L6' x H29.2"	table skirt	paramount	white	8436539291985	18436539291982	1	10	900	1.98	10.3	22.66	88	45	3	34.6	17.7	1.2	80	50	15	31.5	19.7	5.9				
SPTT-00573	paramount partial 180 table skirt	L183 x H74.3 cm L6' x H29.2"	table skirt	paramount	black	8436539291992	18436539291999	1	10	900	1.98	10.3	22.66	88	45	3	34.6	17.7	1.2	80	50	15	31.5	19.7	5.9				
SPTT-00575	paramount partial 180 table skirt	L183 x H74.3 cm L6' x H29.2"	table skirt	paramount	anthracite	8436539295921	18436539295928	1	10	900	1.98	10.3	22.66	88	45	3	34.6	17.7	1.2	80	50	15	31.5	19.7	5.9				
SPTT-00576	paramount partial 180 table skirt	L183 x H74.3 cm L6' x H29.2"	table skirt	paramount	blue	8436539295938	18436539295935	1	10	900	1.98	10.3	22.66	88	45	3	34.6	17.7	1.2	80	50	15	31.5	19.7	5.9				
SPTT-00577	paramount partial 180 table skirt	L183 x H74.3 cm L6' x H29.2"	table skirt	paramount	burgundy	8436539295945	18436539295942	1	10	900	1.98	10.3	22.66	88	45	3	34.6	17.7	1.2	80	50	15	31.5	19.7	5.9				
SPTT-01182	paramount partial 180 table skirt	L183 x H74.3 cm L6' x H29.2"	table skirt	paramount	sand	8436539303190	18436539303197	1	10	900	1.98	10.3	22.66	88	45	3	34.6	17.7	1.2	80	50	15	31.5	19.7	5.9				
SPTT-01183	paramount partial 180 table skirt	L183 x H74.3 cm L6' x H29.2"	table skirt	paramount	ecru	8436539303206	18436539303203	1	10	900	1.98	10.3	22.66	88	45	3	34.6	17.7	1.2	80	50	15	31.5	19.7	5.9				
SPTT-00578	paramount partial 200 table skirt	L200 x H74.3 cm L6.5' x 29.2"	table skirt	paramount	white	8436539292005	18436539292002	1	10	950	2.09	10.8	23.76	87	44	4	34.3	17.3	1.6	80	50	15	31.5	19.7	5.9				
SPTT-00579	paramount partial 200 table skirt	L200 x H74.3 cm L6.5' x 29.2"	table skirt	paramount	black	8436539292012	18436539292019	1	10	950	2.09	10.8	23.76	87	44	4	34.3	17.3	1.6	80	50	15	31.5	19.7	5.9				
SPTT-00581	paramount partial 200 table skirt	L200 x H74.3 cm L6.5' x 29.2"	table skirt	paramount	anthracite	8436539295969	18436539295966	1	10	950	2.09	10.8	23.76	87	44	4	34.3	17.3	1.6	80	50	15	31.5	19.7	5.9				
SPTT-00582	paramount partial 200 table skirt	L200 x H74.3 cm L6.5' x 29.2"	table skirt	paramount	blue	8436539295976	18436539295973	1	10	950	2.09	10.8	23.76	87	44	4	34.3	17.3	1.6	80	50	15	31.5	19.7	5.9				
SPTT-00583	paramount partial 200 table skirt	L200 x H74.3 cm L6.5' x 29.2"	table skirt	paramount	burgundy	8436539295983	18436539295980	1	10	950	2.09	10.8	23.76	87	44	4	34.3	17.3	1.6	80	50	15	31.5	19.7	5.9				
SPTT-01184	paramount partial 200 table skirt	L200 x H74.3 cm L6.5' x 29.2"	table skirt	paramount	sand	8436539303213	18436539303210	1	10	950	2.09	10.8	23.76	87	44	4	34.3	17.3	1.6	80	50	15	31.5	19.7	5.9				
SPTT-01185	paramount partial 200 table skirt	L200 x H74.3 cm L6.5' x 29.2"	table skirt	paramount	ecru	8436539303220	18436539303227	1	10	950	2.09	10.8	23.76	87	44	4	34.3	17.3	1.6	80	50	15	31.5	19.7	5.9				
SPTT-00584	paramount partial 240 table skirt	L244 x H74.3 cm L8' x H29.2"	table skirt	paramount	white	8436539292029	18436539292026	1	8	1100	2.43	10	22	86	40	5	33.9	15.7	2.0	80	50	15	31.5	19.7	5.9				
SPTT-00585	paramount partial 240 table skirt	L244 x H74.3 cm L8' x H29.2"	table skirt	paramount	black	8436539292036	18436539292033	1	8	1100	2.43	10	22	86	40	5	33.9	15.7	2.0	80	50	15	31.5	19.7	5.9				
SPTT-00587	paramount partial 240 table skirt	L244 x H74.3 cm L8' x H29.2"	table skirt	paramount	anthracite	8436539296003	18436539296000	1	8	1100	2.43	10	22	86	40	5	33.9	15.7	2.0	80	50	15	31.5	19.7	5.9				
SPTT-00588	paramount partial 240 table skirt	L244 x H74.3 cm L8' x H29.2"	table skirt	paramount	blue	8436539296010	18436539296017	1	8	1100	2.43	10	22	86	40	5	33.9	15.7	2.0	80	50	15	31.5	19.7	5.9				
SPTT-00589	paramount partial 240 table skirt	L244 x H74.3 cm L8' x H29.2"	table skirt	paramount	burgundy	8436539296027	18436539296024	1	8	1100	2.43	10	22	86	40	5	33.9	15.7	2.0	80	50	15	31.5	19.7	5.9				
SPTT-01186	paramount partial 240 table skirt	L244 x H74.3 cm L8' x H29.2"	table skirt	paramount	sand	8436539303237	18436539303234	1	8	1100	2.43	10	22	86	40	5	33.9	15.7	2.0	80	50	15	31.5	19.7	5.9				
SPTT-01187	paramount partial 240 table skirt	L244 x H74.3 cm L8' x H29.2"	table skirt	paramount	ecru	8436539303244	18436539303241	1	8	1100	2.43	10	22	86	40	5	33.9	15.7	2.0	80	50	15	31.5	19.7	5.9				

Code	Product name	Suitable for the furniture	Use	Shape	Colour	GTIN-13	GTIN-14	Pcs. per bag	Bags per carton	G. per bag	Lb. per bag	GW per carton (kg)	GW per carton (lb)	Polybag size cm	L bag	W bag	H bag	Polybag size in	L bag	W bag	H bag	Carton size cm	L carton	W carton	H carton	Carton size in	L carton	W carton	H carton
SPTT-00590	paramount partial XL table skirt	L76 x H74.3 cm L30" x H29.2"	table skirt	paramount	white	8436539292043	18436539292040	1	20	450	0.99	10.3	22.66	85	41	1	33.5	16.1	0.4	80	50	15	31.5	19.7	5.9				
SPTT-00591	paramount partial XL table skirt	L76 x H74.3 cm L30" x H29.2"	table skirt	paramount	black	8436539292050	18436539292057	1	20	450	0.99	10.3	22.66	85	41	1	33.5	16.1	0.4	80	50	15	31.5	19.7	5.9				
SPTT-00593	paramount partial XL table skirt	L76 x H74.3 cm L30" x H29.2"	table skirt	paramount	anthracite	8436539296041	18436539296048	1	20	450	0.99	10.3	22.66	85	41	1	33.5	16.1	0.4	80	50	15	31.5	19.7	5.9				
SPTT-00594	paramount partial XL table skirt	L76 x H74.3 cm L30" x H29.2"	table skirt	paramount	blue	8436539296058	18436539296055	1	20	450	0.99	10.3	22.66	85	41	1	33.5	16.1	0.4	80	50	15	31.5	19.7	5.9				
SPTT-00595	paramount partial XL table skirt	L76 x H74.3 cm L30" x H29.2"	table skirt	paramount	burgundy	8436539296065	18436539296062	1	20	450	0.99	10.3	22.66	85	41	1	33.5	16.1	0.4	80	50	15	31.5	19.7	5.9				
SPTT-01188	paramount partial XL table skirt	L76 x H74.3 cm L30" x H29.2"	table skirt	paramount	sand	8436539303251	18436539303258	1	20	450	0.99	10.3	22.66	85	41	1	33.5	16.1	0.4	80	50	15	31.5	19.7	5.9				
SPTT-01189	paramount partial XL table skirt	L76 x H74.3 cm L30" x H29.2"	table skirt	paramount	ecru	8436539303268	18436539303265	1	20	450	0.99	10.3	22.66	85	41	1	33.5	16.1	0.4	80	50	15	31.5	19.7	5.9				
SPTT-00614	paramount partial XXL table skirt	L91 x H74.3 cm L36" x H29.2"	table skirt	paramount	white	8436539292128	18436539292125	1	10	550	1.21	6.5	14.3	87	45	1	34.3	17.7	0.4	80	50	15	31.5	19.7	5.9				
SPTT-00615	paramount partial XXL table skirt	L91 x H74.3 cm L36" x H29.2"	table skirt	paramount	black	8436539292135	18436539292132	1	10	550	1.21	6.5	14.3	87	45	1	34.3	17.7	0.4	80	50	15	31.5	19.7	5.9				
SPTT-00617	paramount partial XXL table skirt	L91 x H74.3 cm L36" x H29.2"	table skirt	paramount	anthracite	8436539296201	18436539296208	1	10	550	1.21	6.5	14.3	87	45	1	34.3	17.7	0.4	80	50	15	31.5	19.7	5.9				
SPTT-00618	paramount partial XXL table skirt	L91 x H74.3 cm L36" x H29.2"	table skirt	paramount	blue	8436539296218	18436539296215	1	10	550	1.21	6.5	14.3	87	45	1	34.3	17.7	0.4	80	50	15	31.5	19.7	5.9				
SPTT-00619	paramount partial XXL table skirt	L91 x H74.3 cm L36" x H29.2"	table skirt	paramount	burgundy	8436539296225	18436539296222	1	10	550	1.21	6.5	14.3	87	45	1	34.3	17.7	0.4	80	50	15	31.5	19.7	5.9				
SPTT-01190	paramount partial XXL table skirt	L91 x H74.3 cm L36" x H29.2"	table skirt	paramount	sand	8436539303275	18436539303272	1	10	550	1.21	6.5	14.3	87	45	1	34.3	17.7	0.4	80	50	15	31.5	19.7	5.9				
SPTT-01191	paramount partial XXL table skirt	L91 x H74.3 cm L36" x H29.2"	table skirt	paramount	ecru	8436539303282	18436539303289	1	10	550	1.21	6.5	14.3	87	45	1	34.3	17.7	0.4	80	50	15	31.5	19.7	5.9				



SPTT-00638	table napkin	napkin	50 x 50 cm 19.7" x 19.7"	napkin	cotton	white	8436539292203	18436539292200	10	25	690	1.52	18	39.6	34	23	3	13.4	9.1	1.2	50	40	30	19.7	15.7	11.8
------------	--------------	--------	-----------------------------	--------	--------	-------	---------------	----------------	----	----	-----	------	----	------	----	----	---	------	-----	-----	----	----	----	------	------	------



The scene shot for the cover of this catalogue was undertaken by professionals in a controlled environment and purely for advertising purposes. The chairs are not designed to be used in the manner shown in the photograph. Do not under any circumstances attempt to reproduce the photographed scene and do not use ZOWN® products for any purpose other than the one for which they have been manufactured and marketed, in accordance with the product's recommendations and warnings regarding its use. The manufacturer shall not be liable for any losses, damages or injuries resulting from the improper use of the product or from the failure to comply with the product's instructions.

La escena fotografiada en la portada de este catálogo ha sido efectuada por profesionales en un entorno controlado y con fines puramente publicitarios. Las sillas no han sido diseñadas para el uso expuesto en la imagen. No intente reproducir, bajo ningún concepto, la escena fotografiada y no emplee los productos ZOWN® para un uso diferente al habitual para el que han sido fabricados y comercializados, de conformidad con las recomendaciones y advertencias de uso del producto. El fabricante no será responsable por ninguna pérdida, daño o lesión resultado del uso indebido del producto o por el incumplimiento de las instrucciones del mismo.

La scène photographiée sur la couverture de ce catalogue a été effectuée par des professionnels dans un environnement contrôlé et à des fins strictement publicitaires. Les chaises n'ont pas été conçues pour l'utilisation exposée dans l'image. N'essayez pas de reproduire, sous aucun concept, la scène photographiée et n'utilisez pas les produits ZOWN® pour une utilisation différente de celle pour laquelle ils ont été fabriqués et commercialisés, conformément aux recommandations et aux avertissements d'usage du produit. Le fabricant ne sera considéré responsable d'aucune perte, d'aucun dommage ou d'aucune lésion résultant de l'utilisation incorrecte du produit ou du non-respect de ses instructions.

Das auf der Titelseite dieses Katalogs dargestellte Foto wurde von professionellen Fotografen in einer kontrollierten Umgebung und ausschließlich zu Werbezwecken aufgenommen. Die Stühle wurden nicht zu der auf dem Bild dargestellten Verwendung konzipiert. Versuchen Sie unter keinen Umständen die fotografierte Szene nachzustellen und verwenden Sie die Produkte von ZOWN® nur für den üblichen Verwendungszweck, für den sie hergestellt und vertrieben werden, in Übereinstimmung mit den Empfehlungen und Warnhinweisen zum Einsatz des Produkts. Der Hersteller übernimmt keinerlei Haftung für Verluste, Schäden oder Verletzungen, die sich aus der unsachgemäßen Verwendung bzw. die Nichtbeachtung der Anleitungen ergeben.



ALGUNOS OBJETOS SENSE INTERÉS
-
AQUELLAS COSAS QUE SE'NS ESCAPAN!
+
UNA FORÇA MAJOR
=
ALGUNAS COSAS

ALGUNOS OBJETOS DE DESEO
+
ALGUNOS OBJETOS NECESARIOS
+
ALGUNOS OBJETOS SIN INTERÉS
-
AQUELLAS COSAS QUE SE NOS ESCAPAN!
+
UNA FUERZA MAYOR
=
ALGUNAS COSAS



The Folding Furniture Revolution

The premium collection

100%
PURE HDPE.
NOT MIXED

Zown solely uses 100% pure (first generation) high-density polyethylene, which is not mixed with recycled plastic polymers.

Zown solo utiliza polietileno de alta densidad 100% puro (primera generación), no está mezclado con polímeros de plástico reciclados.

Zown utilise uniquement du polyéthylène haute densité 100% pure (première génération), qui n'est pas mélangé avec des polymères plastiques recyclés.

Zown verwendet ausschließlich 100 % reines HDPE (erster Generation), das nicht mit recycelten Polymerkunststoffen vermischt wird.

**POWDER
COATED
STEEL**

Powder-coated steel frame.

Estructura de acero pintado por pulverización.

Structure en acier peint par pulvérisation.

Gestell aus pulverbeschichtetem Stahl.

Designed in Barcelona. The underside of the table top was designed to reproduce the typical shape of the city blocks with chamfered corners in the Eixample neighbourhood.

Diseñado en Barcelona. Las bóvedas del plano inferior del sobre de la mesa se diseñaron reproduciendo la forma típica de las manzanas con chaflán del barrio del Eixample.

Conçu à Barcelone. Les voûtes du plan inférieur du plateau de table ont été conçues en reproduisant la forme typique des blocs de la ville avec des coins chanfreinés dans le quartier de l'Eixample.

Design in Barcelona. Die Wölbungen auf der Unterseite der Tischplatte geben die typische Form der Häuserblöcke mit abgeschrägten Enden im Stadtteil Eixample wieder.

Longwise and widthwise table connectors.

Sistema de unión longitudinal y transversal.

Système de raccord longitudinal et transversal.

Verbindungssystem zur Längs- und Querverbindung.



Table top and structure warm grey colour. Back, seat and structure of the chair warm grey.

Sobre y estructura de la mesa color gris cálido. Respaldo, asiento y estructura de la silla color gris cálido.

Plateau et structure de la table de couleur gris chaud. Dossier, siège et structure de la chaise couleur gris chaud.

Tischplatte und Tischgestell in warmem Grau. Rückenlehne, Sitzfläche und Gestell des Stuhls in warmem Grau.



UV-protected and water-resistant. Ideal for extensive but not permanent outdoor use.

Protección UV y Hidrófuga. Ideal para uso exterior extensivo, pero no permanente.

Protection UV et hydrofuge. Idéal pour un usage extérieur extensif, mais non permanent.

UV-geschützt und wasserabstoßend. Ideal zur extensiven, aber nicht dauernden Verwendung im Freien.

**LIMITED
10-YEAR
WARRANTY**

**LIMITED
5-YEAR
WARRANTY**

Ten-year or five-year limited warranty for products where expressly indicated on the corresponding catalogue page. For all other products, the European two-year legal guarantee shall apply. See conditions on www.zown.com/warranty

Garantía limitada de 10 o 5 años para aquellos productos en los que así se indique en la correspondiente página del catálogo. Para el resto de productos será aplicable la garantía legal europea de 2 años. Consultar condiciones en www.zown.com/warranty

10 ou 5 ans de garantie limitée pour tous les produits dont la description contient cette indication (veuillez vous reporter à la page correspondante du catalogue). Pour tous les autres produits, c'est la garantie légale européenne de deux ans qui sera appliquée. Consulter les conditions sur www.zown.com/warranty

Auf Waren mit der entsprechenden Angabe auf der jeweiligen Katalogseite leisten wir 10 bzw. 5 Jahre beschränkte Garantie. Für die anderen Waren gilt die gesetzliche europäische Garantiefrist von 2 Jahren. Bedingungen siehe www.zown.com/warranty

The **premium** collection

SPECIAL FEATURES

características especiales / caractéristiques spéciales / besondere merkmale



Sturdy and durability / Firmeza y Durabilidad / Solidité et Durabilité / Stabilität und Dauerhaftigkeit

Equipped with a manual lock for greater stability when in use. The manual lock offers less looseness, thereby making the table more stable. Special long-lasting rivets.

Bloqueadores manuales que minimizan las holguras, proporcionando firmeza y solidez a la mesa. Remaches especiales de larga duración.

Blocage manuel et anneau coulissant qui minimisent les mouvements de la table et donnent de la solidité et stabilité à la table. Rivets spéciaux très résistants dans le temps.

Manuelle Verriegelung zur Verringerung des Spiels und für höhere Stabilität im Einsatz. Spezielle, besonders dauerhafte Niete.



Connectors / Sistema de unión / Système de raccord / Verbindungssystem

Longwise and widthwise table connectors.

Sistema de unión longitudinal y transversal.

Système de raccord longitudinal et transversal.

Verbindungssystem zur Längs- und Querverbindung.

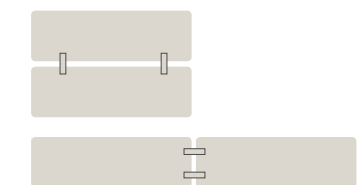

The **premium** collection

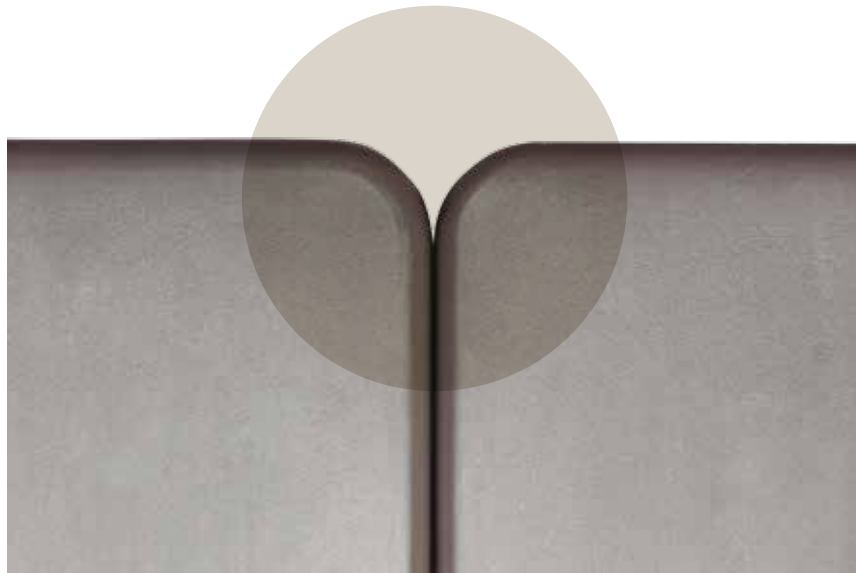

Short radius corners / Esquinas de radio corto / Angles de petit rayon / Runde Ecken mit kurzem Radius

When joining two tables and covering them with a tablecloth, the short radius of the table top's corners makes the joining almost invisible. The gap between the tables is virtually invisible.

Las esquinas de radio corto minimizan el hueco entre las mesas unidas. Bajo el mantel, el hueco entre las esquinas de las mesas unidas resulta casi imperceptible.

Les angles de petit rayon minimisent l'espace entre les tables jointes. Sous la nappe, l'espace entre les angles des tables unies est quasiment imperceptible.

Dank der runden Ecken mit kurzem Radius bleibt bei verbundenen Tischen nur eine ganz kleine Öffnung. Unter der Tischdecke ist die Öffnung zwischen den Ecken der verbundenen Tische praktisch unsichtbar.



Ergonomic / Ergonomía / Ergonomie / Ergonomie

Comfortable for those seated at the end of the table.

Pleno confort también, para los usuarios ubicados en las cabeceras de la mesa.

Confort total aussi pour les personnes situées en bout de table.

Uneingeschränkter Sitzkomfort auch an der Kopfseite des Tisches.



Aesthetically appealing / Apariencia estética / Aspect esthétique / Gefälliges Aussehen

Even without skirting, the table is aesthetically pleasing for hotel and restaurant settings. Even when uncovered, it is aesthetically pleasing.

La apariencia de la mesa cubierta sólo con un mantel es elegante para su uso en la restauración, sin necesidad de emplear faldones. Aún sin cubrir, la mesa es estéticamente elegante.

L'apparence de la table couverte seulement avec une nappe est élégante pour son utilisation en restauration, sans nécessité d'utiliser des jupons. Même sans nappe, la table est élégante.

Der Tisch bietet auch ohne Skirting ein gefälliges Aussehen für Hotel- und Restaurantumgebungen und ist sogar ohne Tischdecke ästhetisch attraktiv.

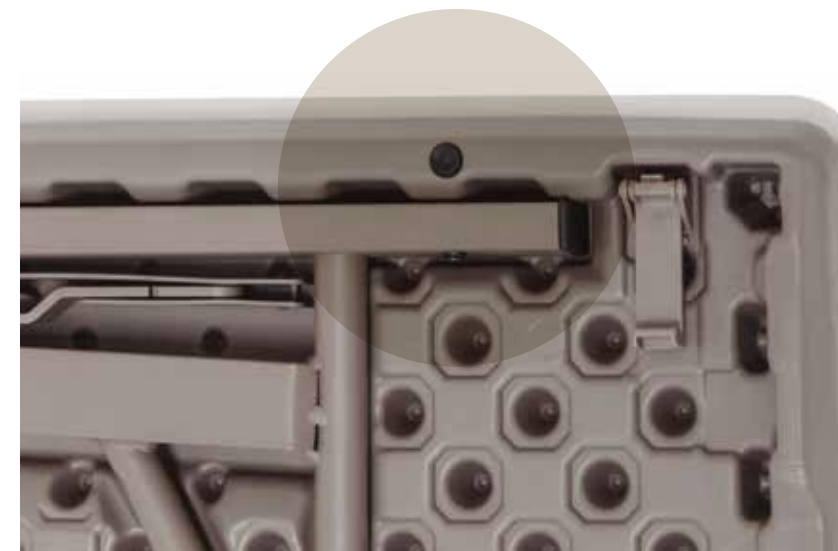

Slip-resistant fasteners for secure stacking.

Tacos antideslizantes para una apilabilidad segura.

Tampons antidérapants pour une empilabilité sûre et efficace.

Rutschfeste Halter für eine sichere Stapelfähigkeit.

The **premium** collection



Solid welded joints, nuts and bolts.
Tornillería y soldaduras sólidas.
Visserie et soudures solides.
Solide Schraub- und Schweißverbindungen.



Table leg features / Singularidades de las patas / Particularité des pieds / Besonderheiten der Tischbeine

Special leg clips. New leg clips, designed for square-shaped table legs. Accessory gliders. Special foot caps, designed to fit gliders.

Clips de las patas. Clips especiales para albergar patas cuadradas. Reguladores. Tacos diseñados para albergar los reguladores de altura (accesorio disponible).

Clips des pieds. Clips spéciaux pour bloquer des pieds carrés. Régulateurs. Embouts conçus pour encastrer les vérins de réglage (accessoire disponible à la demande sur tarif).

Besondere Beinclammern mit speziellem Design für viereckige Tischbeine. Höhenregler. Spezielle Fußabdeckungen zur Aufnahme der Höhenregler (Sonderzubehör).

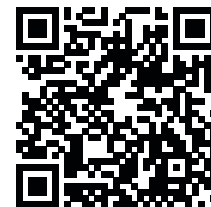

The Zown
premiumcollection
video

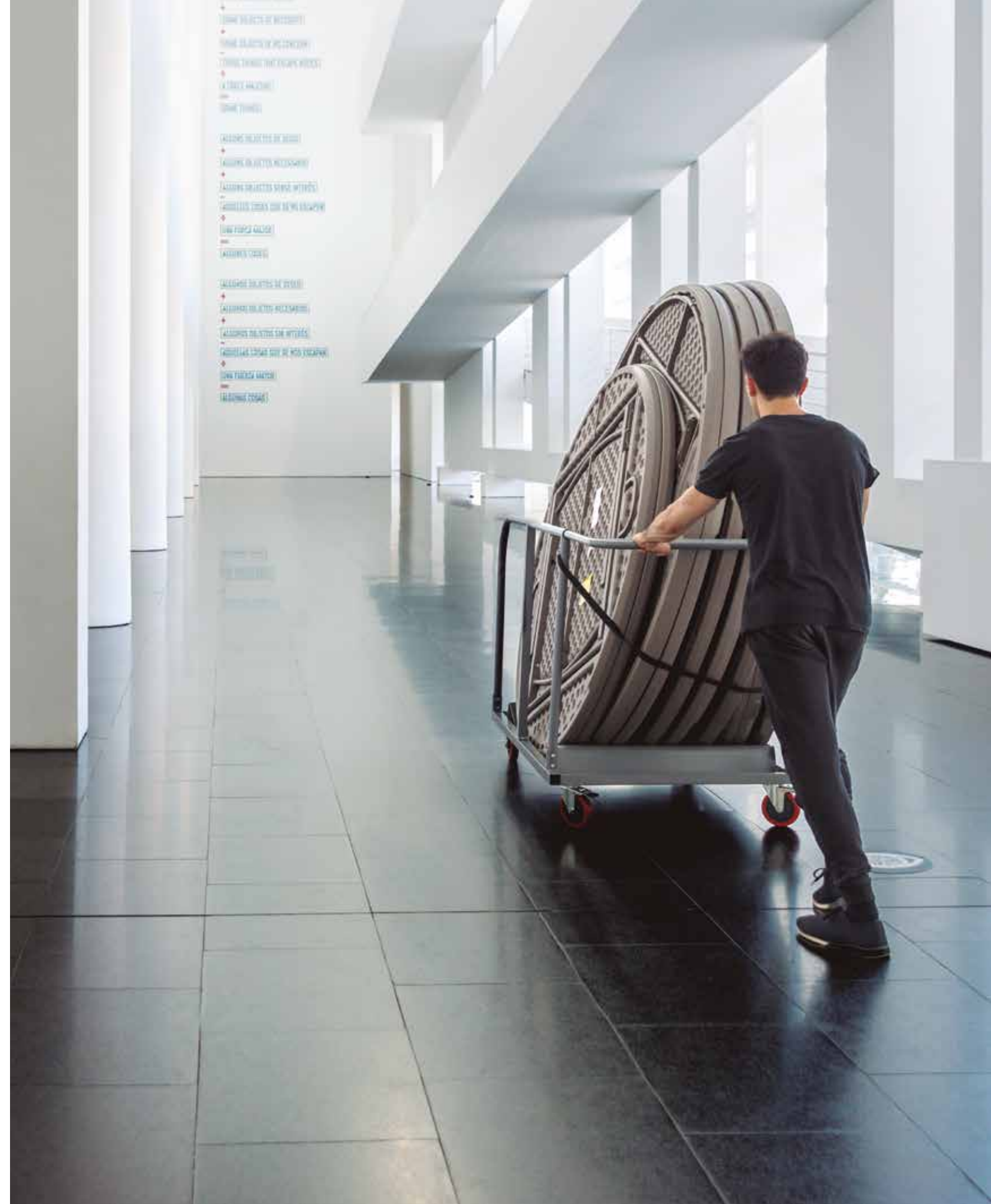

Styles

estilos/ style / stile

FULL TABLE COVER SHAPES

stretch

90% PES 10% LYCRA,
190-200 g/m², knitted

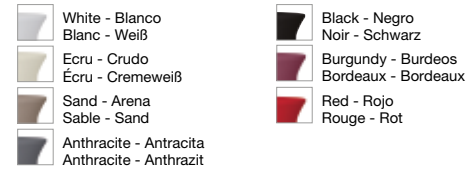

paramount

100% PES,
190-200 g/m², knitted

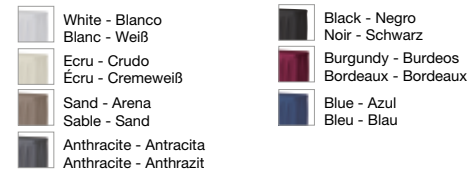

plain

100% PES,
190-200 g/m², knitted

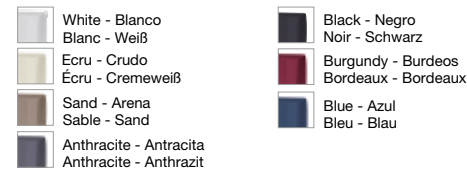

The plain covers for the rectangular tables and the XLangle and XLcrescent tables, as well as the Stretch cover for the XLangle, have eyelets through which the clip for the table joining system can be passed. The tables can be joined even when the covers are in place. (Optional in the stretch cover for the XL6).

Las fundas plain de las mesas rectangulares y de las mesas XLangle y XLcrescent, así como la funda Stretch de la XLangle cuentan con ojales a través de los que puede pasar el clip del sistema de unión de mesas. Las mesas se pueden unir incluso cubiertas con fundas. (En la funda stretch de la XL6 es opcional).

Les housses plain des tables rectangulaires et des tables XLangle et XLcrescent, ainsi que la housse Stretch de la table XLangle disposent de boutonnières à travers lesquelles peut passer le clip du système d'union des tables. Les tables peuvent s'unir y compris couvertes avec des housses. (Dans la housse stretch de la XL6, en option).

Die Tischhussen plain der rechteckigen Tische sowie der Tische XLangle und XLcrescent und die Tischhuse Stretch der XLangle verfügen über Öffnungen für die Klammern des Tischverbindungssystems. So können auch mit Hussen abgedeckte Tische verbunden werden. (Bei der Huse Stretch der Tische XL6 ist diese Ausführung optional).

PARTIAL TABLE SKIRT

paramount

100% PES,
190-200 g/m², knitted

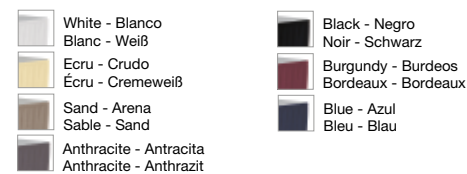

TABLECLOTHS

tablecloths

100% CO,
230 g/m²



TOP COVER

stretch

90% PES 10% LYCRA,
200 g/m², knitted

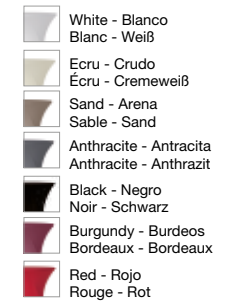
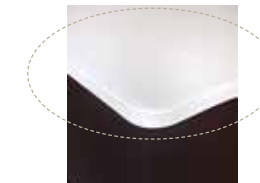

XL4

TABLE MESA TABLE TISCH

L4' x W30" x H30"
L122 x W76.2 x H76.2 cm



Aesthetically elegant
without the need to be
covered by skirting

Estéticamente elegante sin necesidad
de cubrir con faldones

Esthétiquement élégante sans avoir besoin
de couvrir avec des nappes

Elegante Ästhetik auch ohne Hussen





REF. BT004X011A		Gross weight	30.4 lb	Net weight	25.8 lb	Recommended maximum weight	400 lb
		Peso bruto	13.8 kg	Peso neto	11.7 kg	Peso máximo recomendado	181.4 kg
		Poids brut		Poids net		Poids maximum recommandé	
		Bruttogewicht		Nettogewicht		Empfohlenes Höchstgewicht	



XLtrolley available for 24 tables. See page 40.
 Carro XLtrolley disponible para 24 mesas. Ver pág. 40.
 Chariot XLtrolley disponible pour 24 tables. Voir page 40.
 Wagen XLtrolley lieferbar für 24 Tische. Siehe S.40.



Ref. 15-0093

Accessory gliders. Special foot caps, designed to fit gliders.
 Reguladores. Tacos diseñados para albergar los reguladores de altura (accesorio disponible).
 Régulateurs. Embouts conçus pour encastrer les vérins de réglage (accessoire disponible à la demande sur tarif).
 Höhenregler. Spezielle Fußabdeckungen zur Aufnahme der Höhenregler (Sonderzubehör).

stretch

	1200 1201 1202 1203 1204 1205 1206	table cover
	1207 1208 1209 1210 1211 1212 1213	top cover

paramount

	1221 1222 1223 1224 1225 1226 1227	table cover
0555		tablecloth

plain

	1214 1215 1216 1217 1218 1219 1220	table cover
0555		tablecloth

XL6

TABLE MESA TABLE TISCH

L6' x W30" x H30"
L182.8 x W76.2 x H76.2 cm



Complete comfort also
for users located at the
heads of the table

Pleno confort también para los usuarios ubicados
en las cabeceras de la mesa

Tout confort aussi pour les utilisateurs
situés aux têtes de la table

Voller Komfort auch für die Benutzer
an den Tischenden





H30"
H76.2 cm



1.96"
50 mm

L6' x W30"
L182.8 x W76.2 cm

REF.
BT006X015A



Gross weight
Peso bruto
Poids brut
Bruttogewicht

48.18 lb
21.9 kg

Net weight
Peso neto
Poids net
Nettogewicht

35.4 lb
16.1 kg

Recommended maximum weight
Peso máximo recomendado
Poids maximum recommandé
Empfohlenes Höchstgewicht

700 lb
317.5 kg



XLtrolley available for 18 tables. See page 40.
Carro XLtrolley disponible para 18 mesas. Ver pág. 40.
Chariot XLtrolley disponible pour 18 tables. Voir page 40.
Wagen XLtrolley lieferbar für 18 Tische. Siehe S.40.



Ref. 15-0093

Accessory gliders. Special foot caps, designed to fit gliders.
Reguladores. Tacos diseñados para albergar los reguladores de altura (accesorio disponible).
Régulateurs. Embouts conçus pour encastrer les vérins de réglage (accessoire disponible à la demande sur tarif).
Höhenregler. Spezielle Fußabdeckungen zur Aufnahme der Höhenregler (Sonderzubehör).

stretch



0261	0876	0874	0873	0258	0875	0257	table cover
0508	0880	0878	0877	0505	0879	0504	top cover

paramount



1235	1236	1237	1238	1239	1240	1241	table cover
0556							tablecloth

plain



1228	1229	1230	1231	1232	1233	1234	table cover
0556							tablecloth



XL8

TABLE MESA TABLE TISCH

L8' x W30" x H30"
L243.8 x W76.2 x H76.2 cm



The square section legs and the design of the table top provide an elegant and sober aesthetic appearance

Las patas de sección cuadrada y el diseño del sobre confieren una apariencia estética elegante y sobria

Les pieds à section carrée et le dessin du plateau confèrent une apparence esthétique élégante et sobre

Die Beine mit quadratischem Querschnitt und das Design der Platte sorgen für schlichte Eleganz





H30"
H76.2 cm



REF.
BT008X007A



Gross weight
Peso bruto
Poids brut
Bruttogewicht

56.9 lb
25.8 kg

Net weight
Peso neto
Poids net
Nettogewicht

48.6 lb
22.1 kg

Recommended maximum weight
Peso máximo recomendado
Poids maximum recommandé
Empfohlenes Höchstgewicht

1.000 lb
453.6 kg



XLtrolley available for 14 tables. See page 40.
Carro XLtrolley disponible para 14 mesas. Ver pág. 40.
Chariot XLtrolley disponible pour 14 tables. Voir page 40.
Wagen XLtrolley lieferbar für 14 Tische. Siehe S. 40.



Ref. 15-0093

Accessory gliders. Special foot caps, designed to fit gliders.
Reguladores. Tacos diseñados para albergar los reguladores de altura (accesorio disponible).
Régulateurs. Embouts conçus pour encasturer les vérins de réglage (accessoire disponible à la demande sur tarif).
Höhenregler. Spezielle Fußabdeckungen zur Aufnahme der Höhenregler (Sonderzubehör).

stretch



	0268 0892 0890 0889 0265 0891 0264	table cover
	0515 0896 0894 0893 0512 0895 0511	top cover

paramount



	1249 1250 1251 1252 1253 1254 1255	table cover
	0557	tablecloth

plain



	1242 1243 1244 1245 1246 1247 1248	table cover
	0557	tablecloth

XL Angle

TABLE MESA TABLE TISCH
 L30" x W30" x H30"
 L76.2 x W76.2 x H76.2 cm

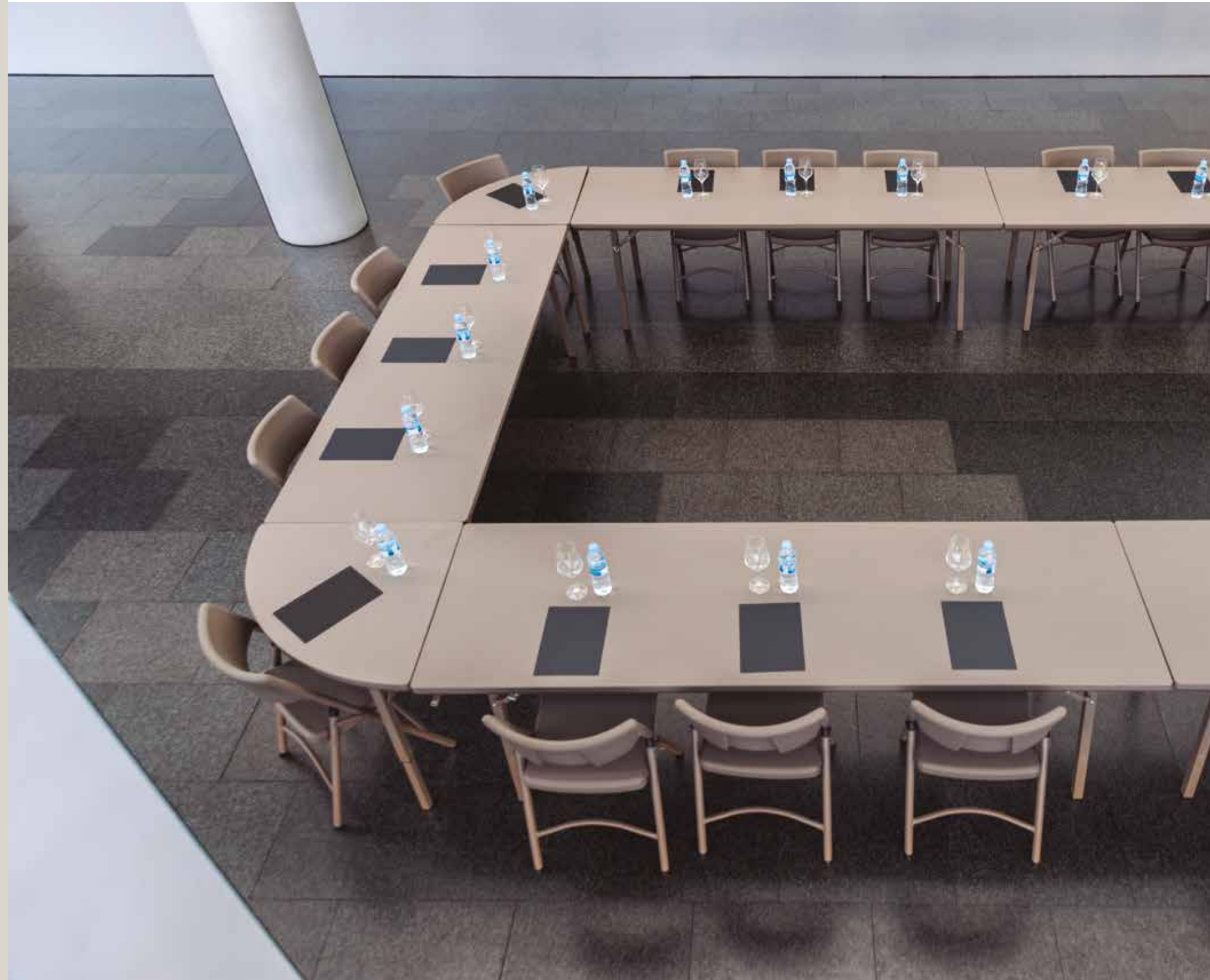

The joining system provides
 sturdiness and solidity
 to table composition

El sistema de unión proporciona firmeza y
 solidez a la composición de mesas

Le système d'union confère fermeté et
 solidité à la composition des tables

Das Verbindungssystem verleiht den
 Tischverbindungen Stabilität und Standfestigkeit



XL Angle



H30"
H76.2 cm

L30" x W30"
L76.2 x W76.2 cm

REF.
PT013X002A



Gross weight	Net weight
Peso bruto 22.8 lb	Peso neto 9.4 lb
Poids brut 10.36 kg	Poids net 4.3 kg
Bruttogewicht	Nettogewicht
Recommended maximum weight	
Peso máximo recomendado 250 lb	
Poids maximum recommandé 113.4 kg	
Empfohlenes Höchstgewicht	



Ref. 15-0093

Accessory gliders. Special foot caps, designed to fit gliders.
Reguladores. Tacos diseñados para albergar los reguladores de altura (accesorio disponible).
Régulateurs. Embouts conçus pour encastrer les vérins de réglage (accesoire disponible à la demande sur tarif).
Höhenregler. Spezielle Fußabdeckungen zur Aufnahme der Höhenregler (Sonderzubehör).

stretch



0921 0927 0925 0924 0922 0926 0923 table cover

paramount



1284 1285 1286 1287 1288 1289 1290 table cover
0558 tablecloth

plain



1277 1278 1279 1280 1281 1282 1283 table cover
0558 tablecloth

XL Crescent

TABLE MESA TABLE TISCH

L7.75' x W40.2" x H30"
L236 x W102.3 x H76.2 cm

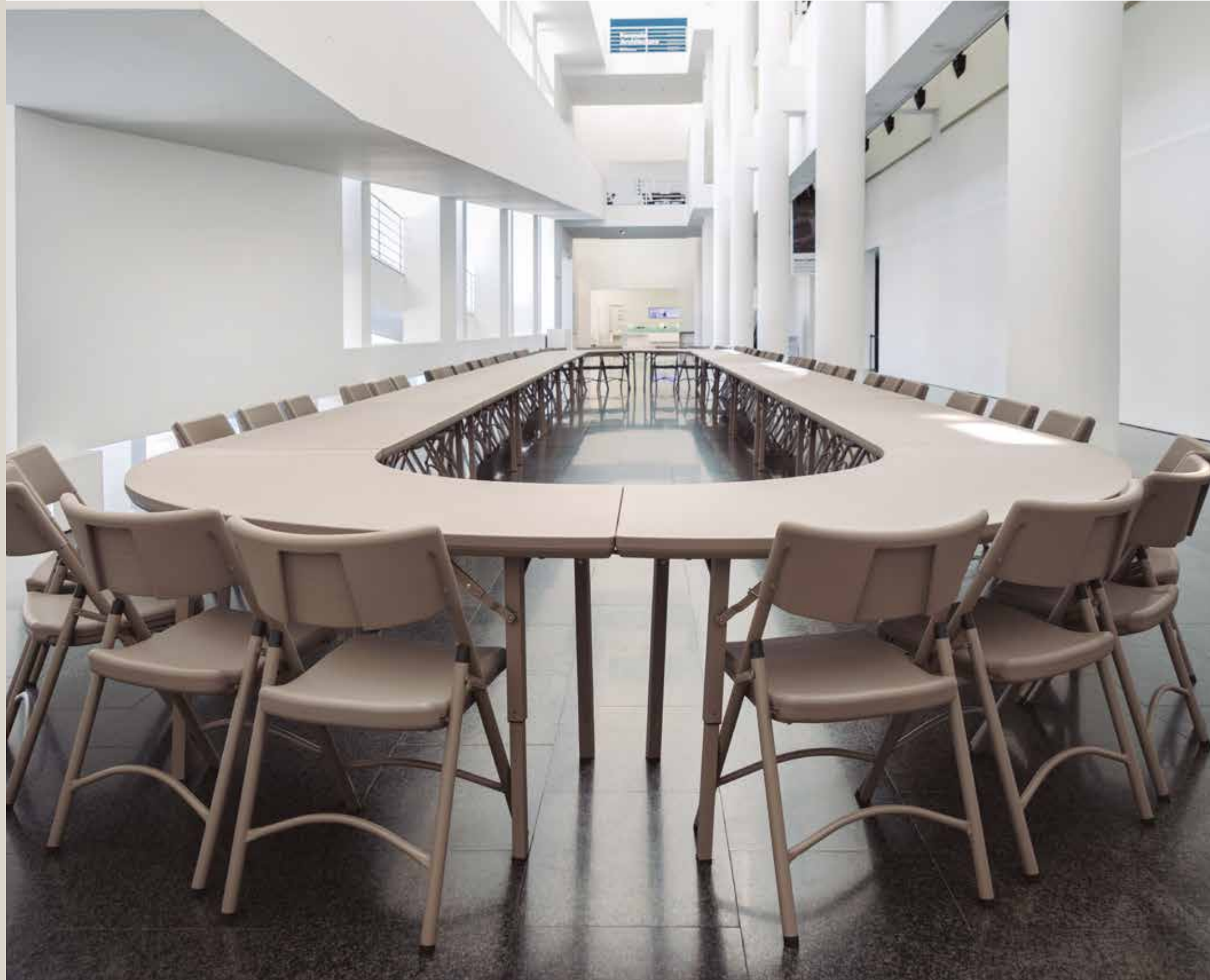

The wide variety of possible combinations allows any space to be optimised

La amplia variedad de combinaciones posibles permite optimizar cualquier espacio

La large variété de combinaisons possibles permet d'optimiser n'importe quel espace

Die Vielfalt der möglichen Kombinationen erlaubt eine optimale Nutzung des Platzangebots



XL Crescent

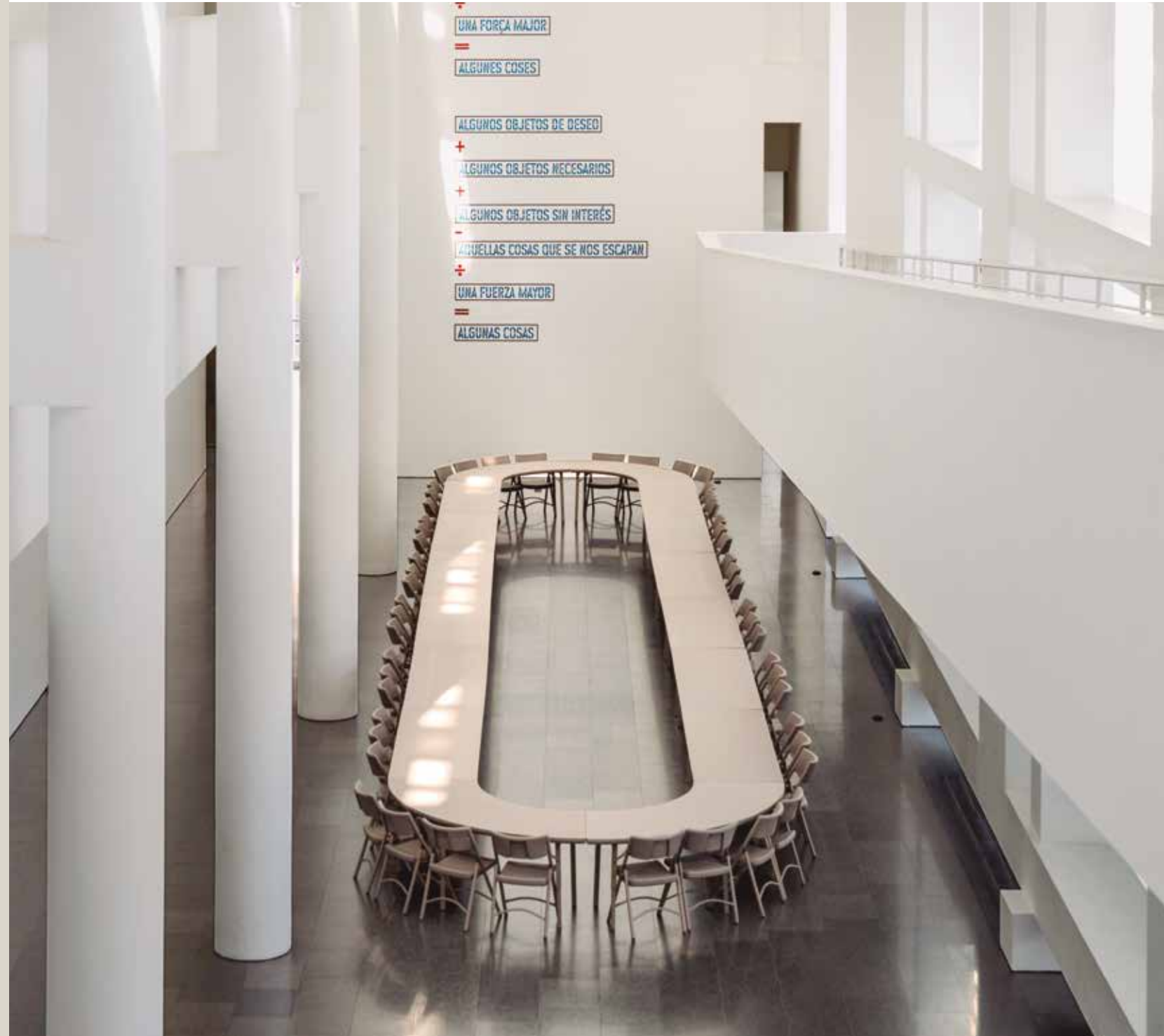

REF. PT013X002A **4-5**

Gross weight **51.5 lb** Net weight **41.1 lb**
 Peso bruto **23.4 kg** Peso neto **18.7 kg**
 Poids brut Bruttogewicht Poids net Nettogewicht

Recommended maximum weight **800 lb**
 Peso máximo recomendado **363.8 kg**
 Poids maximum recommandé **Empfohlenes Höchstgewicht**

Accessory gliders. Special foot caps, designed to fit gliders.
 Reguladores. Tacos diseñados para albergar los reguladores de altura (accesorio disponible).
 Régulateurs. Embouts conçus pour encastrer les vérins de réglage (accessoire disponible à la demande sur tarif).
 Höhenregler. Spezielle Fußabdeckungen zur Aufnahme der Höhenregler (Sonderzubehör).
 Ref. 15-0093

stretch 0903 0909 0907 0906 0904 0908 0905 table cover

paramount 1263 1264 1265 1266 1267 1268 1269 Ext. table cover
 1270 1271 1272 1273 1274 1275 1276 Int. table cover
 0559 tablecloth

plain 1256 1257 1258 1259 1260 1261 1262 table cover
 0559 tablecloth

XL Trolley

TROLLEY CARRO CHARIOT WAGEN
 L(76"+24") x W30.3" x H45.3"
 L(193+61) x W77 x H115 cm



H45.3"
H115 cm

L(76" + 24") x W30.3"
L(193 + 61) x W77 cm

Eases the transport and storage of tables, saving space and time

Facilita el transporte y almacenaje de mesas ahorrando espacio y tiempo

Facilite le transport et le stockage des tables en économisant de l'espace et du temps

Erleichtert den zeitsparenden Transport und die platzsparende Lagerung der Tische



REF.
RA-102A

Gross weight
Peso bruto **77.95 lb**
Poids brut **35.35 kg**
Bruttogewicht

Net weight
Peso neto **65.22 lb**
Poids net **29.59 kg**
Nettogewicht

XL Trolley



Capacity: **24 pcs. XL4**
 Capacidad: **24u. XL4**
 Capacité: **24u. XL4**
 Fassungsvermögen: **24 Stk. XL4**



Capacity: **18 pcs. XL6**
 Capacidad: **18u. XL6**
 Capacité: **18u. XL6**
 Fassungsvermögen: **18 Stk. XL6**



Capacity: **14 pcs. XL8**
 Capacidad: **14u. XL8**
 Capacité: **14u. XL8**
 Fassungsvermögen: **14 Stk. XL8**



Peripheral posts to hold the stacked tables in place.
 Postes périphériques pour immobiliser les tables empilées.
 Poteaux périmétraux pour immobilisation des tables empilées.
 Sicherungsstangen verhindern das Verrutschen der gestapelten Tische.



Handle specially designed to protect the hands.
 Asa especial para proteger las manos.
 Anse spécialement conçue pour protéger les mains.
 Ein spezieller Griff schützt die Hände.

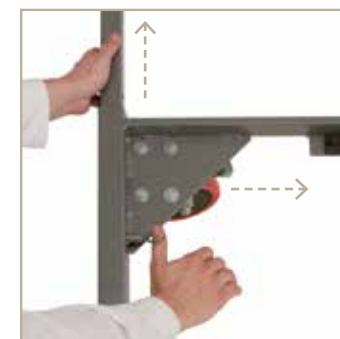

Expandable base to adjust to the respective table lengths.
 Base extensible para adecuarla a la longitud de las distintas mesas.
 Base extensible pour une adaptation à la longueur des différentes tables.
 Die ausziehbare Ladefläche lässt sich an die jeweilige Tischlänge anpassen.



Four polyurethane wheels with built-in brake. (Two fixed wheels and two pivoting wheels).
 4 ruedas de poliuretano con freno incorporado (2 ruedas fijas y 2 ruedas pivotantes).
 4 roulettes en polyuréthane avec frein intégré. (2 roulettes fixes et 2 roulettes pivotantes).
 4 PU-Räder mit integrierter Bremse. (2 feststehende Räder und 2 Schwenkräder).



Part to hold the removable posts when folded.
 Pieza para sujetar los postes extraíbles en posición de plegado.
 Pièce pour les poteaux extractibles en position de pliage.
 Halterungsvorrichtung für die herausnehmbaren Stangen in abgeklappter Position.



Bar with automatic unlocking mechanism which allows the vertical bracket to be folded.
 Barra con mecanismo automático para desbloquear y permitir el plegado del soporte vertical.
 Barre avec mécanisme automatique pour blocage et déblocage et pour permettre le pliage du support vertical.
 Stange mit automatischem Mechanismus zum Entriegeln und Zusammenklappen des senkrechten Gestells.

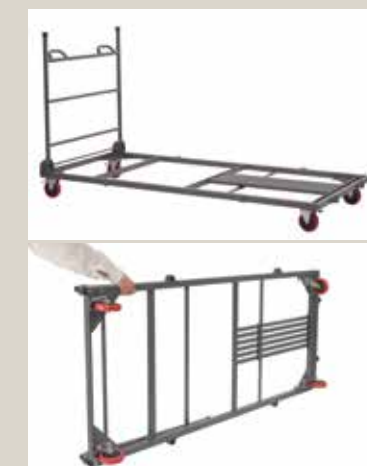

Trolley in fully folded position. Occupies a minimum of space. All parts are integrated to prevent loss.
 Carro totalmente plegado. Ocupa mínimo espacio y todos sus componentes quedan integrados para no extraviarlos.
 Chariot entièrement plié. Occupe peu de place. Tous ses composants sont intégrés pour ne pas les perdre.
 Der Wagen lässt sich vollständig zusammenklappen. Platzsparend sind alle Bestandteile integriert, damit sie nicht verloren gehen.

POWDER
COATED
STEEL

Planet4

TABLE MESA TABLE TISCH
 ø4' x H30"
 ø122 x H76.2 cm

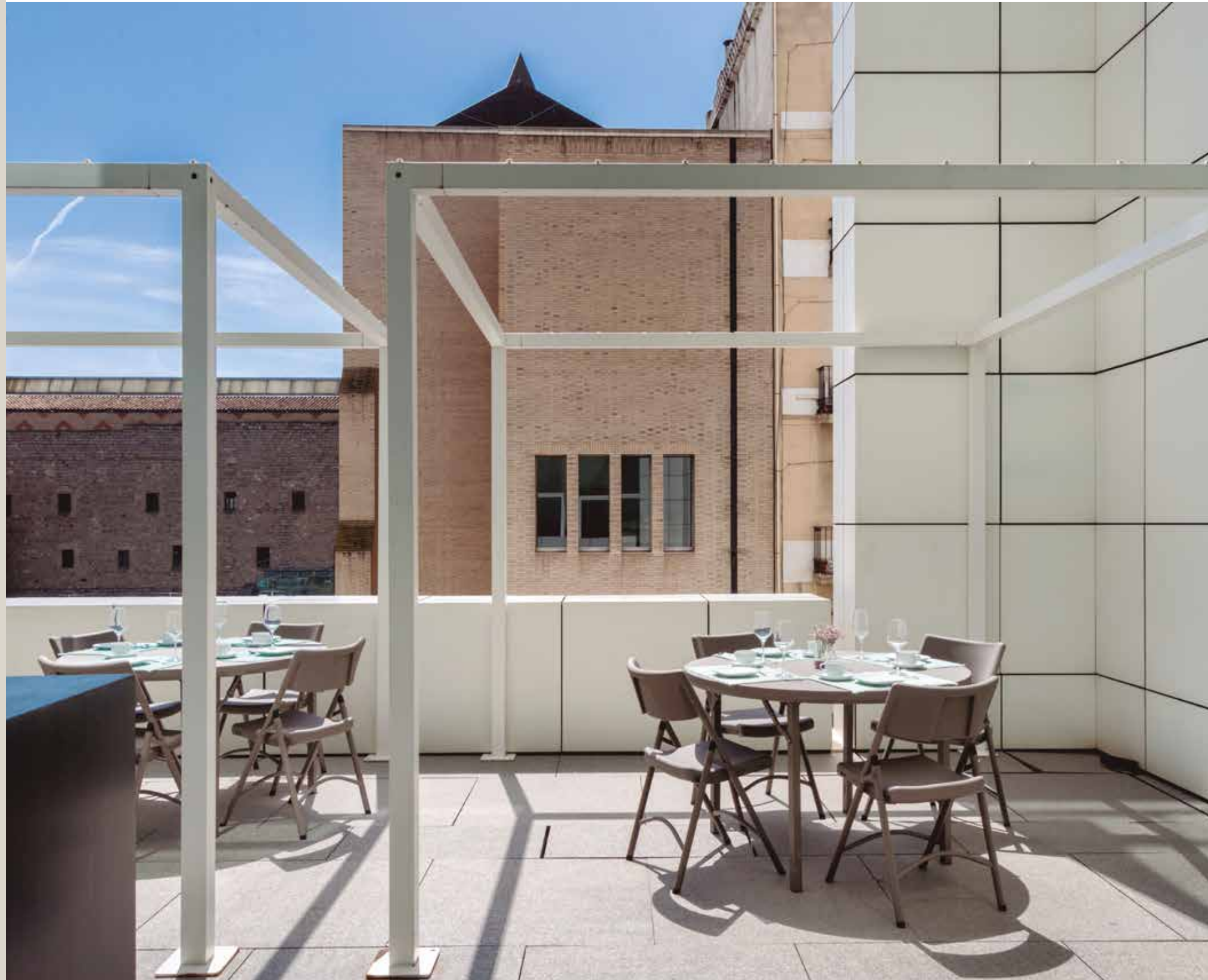

UV and Water-resistant furniture. Ideal for changeable weather

Mobiliario resistente a los rayos ultravioleta y al agua. Ideal para climas cambiantes

Meubles résistants aux UV et à l'eau. Idéal pour un temps changeant

UV- und wasserbeständige Möbel. Ideal für wechselhaftes Wetter



Planet4



REF. BT048X005A		Gross weight	40.2 lb	Net weight	33.8 lb	Recommended maximum weight	363.8 kg
		Peso bruto	18.3 kg	Peso neto	15.3 kg	Peso máximo recomendado	800 lb
		Poids brut		Poids net		Poids maximum recommandé	
		Bruttogewicht		Nettogewicht		Empfohlenes Höchstgewicht	



Planetrolley available for 14 tables.
See page 56.
Carro Planetrolley disponible para 14 mesas.
Ver pág. 56.
Chariot Planetrolley disponible pour 14 tables.
Voir page 56.
Wagen Planetrolley lieferbar für 14 Tische.
Siehe S.56.

stretch



0226 1008 1006 1005 0223 1007 0222 table cover
0466 1012 1010 1009 0463 1011 0462 top cover

paramount



1298 1299 1300 1301 1302 1303 1304 table cover
0551 tablecloth

plain



1291 1292 1293 1294 1295 1296 1297 table cover
0551 tablecloth

Planet5

TABLE MESA TABLE TISCH

ø5' x H30"
ø152.4 x H76.2 cm



Made with materials
that resist moisture and
are easy to clean

Fabricado con materiales resistentes
a la humedad y fáciles de limpiar

Fabriqué avec des matériaux résistants
à l'humidité et faciles à nettoyer

Hergestellt aus feuchtigkeitsbeständigen
und pflegeleichten Materialien





REF. BT060X007A		Gross weight	56 lb	Net weight	46.2 lb	Recommended maximum weight	900 lb
		Peso bruto	25.4 kg	Peso neto	21 kg	Peso máximo recomendado	408.2 kg
		Poids brut		Poids net		Poids maximum recommandé	
		Bruttogewicht		Nettogewicht		Empfohlenes Höchstgewicht	



Planetrolley available for 14 tables. See page 56.
 Carro Planetrolley disponible para 14 mesas. Ver pág. 56.
 Chariot Planetrolley disponible pour 14 tables. Voir page 56.
 Wagen Planetrolley lieferbar für 14 Tische. Siehe S.56.



Ref. 15-0093
 Accessory gliders. Special foot caps, designed to fit gliders.
 Reguladores. Tacos diseñados para albergar los reguladores de altura (accesorio disponible).
 Régulateurs. Embouts conçus pour encastrer les vérins de réglage (accessoire disponible à la demande sur tarif).
 Höhenregler. Spezielle Fußabdeckungen zur Aufnahme der Höhenregler (Sonderzubehör).

stretch

0233 1020 1018 1017 0230 1019 0229 table cover
 0473 1024 1022 1021 0470 1023 0469 top cover

paramount

1312 1313 1314 1315 1316 1317 1318 table cover
 0552 tablecloth

plain

1305 1306 1307 1308 1309 1310 1311 table cover
 0552 tablecloth

Planet6

TABLE MESA TABLE TISCH

ø6' x H30"
ø182.8 x H76.2 cm

Shock-proof and easy to transport by wheeling thanks to the robustness of the table top

Resistente a los impactos y fácil de transportar rodando gracias a la robustez del sobre

Résistant aux chocs et facile à transporter en roulant grâce à la robustesse du plateau

Stoßfest und dank der robusten Platten leicht auf Rädern zu transportieren





REF. BT072X001A		Gross weight	79 lb	Net weight	65.2 lb	Recommended maximum weight	1.200 lb
		Peso bruto	35.9 kg	Peso neto	29.6 kg	Peso máximo recomendado	544.3 kg
		Poids brut		Poids net		Poids maximum recommandé	
		Bruttogewicht		Nettogewicht		Empfohlenes Höchstgewicht	



Planetrolley available for 13 tables. See page 56.
 Carro Planetrolley disponible para 13 mesas. Ver pág. 56.
 Chariot Planetrolley disponible pour 13 tables. Voir page 56.
 Wagen Planetrolley lieferbar für 13 Tische. Siehe S. 56.



Ref. 15-0093

Accessory gliders. Special foot caps, designed to fit gliders.
 Reguladores. Tacos diseñados para albergar los reguladores de altura (accesorio disponible).
 Régulateurs. Embouts conçus pour encastrer les vérins de réglage (accessoire disponible à la demande sur tarif).
 Höhenregler. Spezielle Fußabdeckungen zur Aufnahme der Höhenregler (Sonderzubehör).

stretch



	0247 1044 1042 1041 0244 1043 0243	table cover
	0487 1048 1046 1045 0484 1047 0483	top cover

paramount



	1326 1327 1328 1329 1330 1331 1332	table cover
	0554	tablecloth

plain



	1319 1320 1321 1322 1323 1324 1325	table cover
	0554	tablecloth

PlanetTrolley

TROLLEY CARRO CHARIOT WAGEN

L(52" + 11.8") x W32.7" x H40.2"
L(132 + 30) x W83.2 x H102 cm



H40.2"
H102 cm

L(52" + 11.8") x W32.7"
L(132 + 30) x W83.2 cm

Eases the transport and storage of tables, saving space and time

Facilita el transporte y almacenaje de mesas ahorrando espacio y tiempo

Facilite le transport et le stockage des tables en économisant de l'espace et du temps

Erleichtert den zeitsparenden Transport und die platzsparende Lagerung der Tische

REF. RA-106A	Gross weight	75.9 lb	Net weight	67.9 lb
	Peso bruto	34.5 kg	Peso neto	30.8 kg
	Poids brut	34.5 kg	Poids net	30.8 kg
	Bruttogewicht	34.5 kg	Nettogewicht	30.8 kg

PlanetTrolley

POWDER
COATED
STEEL



Capacity: **14 pcs. Planet4**
 Capacidad: **14u. Planet4**
 Capacité: **14u. Planet4**
 Fassungsvermögen: **14 Stk. Planet4**



Capacity: **14 pcs. Planet5**
 Capacidad: **14u. Planet5**
 Capacité: **14u. Planet5**
 Fassungsvermögen: **14 Stk. Planet5**



Capacity: **13 pcs. Planet6**
 Capacidad: **13u. Planet6**
 Capacité: **13u. Planet6**
 Fassungsvermögen: **13 Stk. Planet6**



Extendable handle.
 Asa extensible.
 Anse extensible.
 Ausziehbarer Griff.



Polyester strap with tensioning mechanism to hold the tables in an upright position when the trolley is half loaded.
 Correa de poliéster con tensor para mantener las mesas verticales si el carro está a media carga.
 Courroie en polyester avec tendeur pour le maintien vertical des tables lorsque le chariot est à moitié plein.
 Spannriemen aus Polyester zur Befestigung der senkrecht aufgestellten Tische, wenn der Wagen nur halbvoll ist.



Wide support platform with a non-slip mat.
 Amplia plataforma de apoyo con alfombrilla antideslizante.
 Vaste plate-forme d'appui avec tapis antidérapant.
 Breite Auflagefläche mit rutschfestem Belag.



Four polyurethane wheels with built-in brake. (Two fixed wheels and two pivoting wheels).
 4 ruedas de poliuretano con freno incorporado (2 ruedas fijas y 2 ruedas pivotantes).
 4 roulettes en polyuréthane avec frein intégré. (2 roulettes fixes et 2 roulettes pivotantes).
 4 PU-Räder mit integrierter Bremse. (2 feststehende Räder und 2 Schwenkräder).



Cocktail30

TABLE MESA TABLE TISCH

Ø30" x H43.6"
Ø 76.2 x h110.8 cm



The bevelled table top and angle of the legs give a slender and subtle structure

El sobre biselado y la inclinación de las patas rectas confieren una apariencia esbelta y sutil

Le plateau biseauté et l'inclinaison des pieds droits confèrent une apparence svelte et subtile

Die abgefasten Kanten der Platte und die Neigung der geraden Beine sorgen für ein schlankes, raffiniertes Aussehen



Cocktail30



H43.6"
H110.8 cm

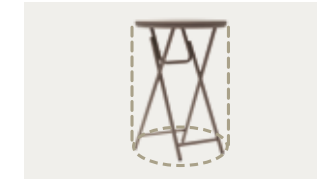

Large base which provides great stability.

Base amplia que proporciona gran estabilidad.

Base large qui confère une grande stabilité.

Eine breite Standfläche sorgt für eine ausgezeichnete Standfestigkeit.



Light and easy to fold and store.

Ligera y fácil de plegar y guardar.

Lègere, facile à plier et à ranger.

Leicht und einfach zusammenzuklappen und zu verstauen.



Manual lock for legs when in use.

Bloqueador de las patas en posición de uso.

Blocage des pieds en position d'utilisation.

Arretierung für Tischbeine in aufgeklappter Position.

REF.
PT017X002A

Gross weight
Peso bruto
Poids brut
Bruttogewicht

22.6 lb
10.3 kg

Net weight
Peso neto
Poids net
Nettogewicht

18.8 lb
8.4 kg

Recommended maximum weight
Peso máximo recomendado
Poids maximum recommandé
Empfohlenes Höchstgewicht

400 lb
181.4 kg



Cocktailtrolley available for 20 tables.
See page 64.

Carro Cocktailtrolley disponible para 20 mesas.
Ver pág. 64.

Chariot Cocktailtrolley disponible pour 20 tables.
Voir page 64.

Wagen Cocktailtrolley lieferbar für 20 Tische.
Siehe S.64.

stretch



0296 1056 1054 1053 0293 1055 0292 table cover
0543 1060 1058 1057 0540 1059 0539 top cover

paramount



1340 1341 1342 1343 1344 1345 1346 table cover
0547 tablecloth

plain



1333 1334 1335 1336 1337 1338 1339 table cover
0547 tablecloth

Cocktail Trolley

TROLLEY CARRO CHARIOT WAGEN

L47.6" x W35" x H39.6"
L121 x W89 x H101 cmH39.6"
H101 cmL47.6" x W35"
L121 x W89 cm

Capacity: **20 pcs. Cocktail30**
 Capacidad: **20u. Cocktail30**
 Capacité: **20u. Cocktail30**
 Fassungsvermögen: **20 Stk. Cocktail30**

Eases the transport and storage of tables, saving space and time

Facilita el transporte y almacenaje de mesas ahorrando espacio y tiempo

Facilite le transport et le stockage des tables en économisant de l'espace et du temps

Erleichtert den zeitsparenden Transport und die platzsparende Lagerung der Tische

REF.	Gross weight	Net weight
RA-277	26.9 kg	25.5 kg
	Peso bruto 59.17 lb	Peso neto 56.2 lb
	Poids brut	Poids net
	Bruttogewicht	Nettogewicht

Cocktail **Trolley**

Locking bar which moves along the side rails to fix the tables in position even at half load. The bar revolves around one of the rails to allow access to the back of the trolley, making it easier to load.



Barra bloqueadora que se desplaza a lo largo de las barandillas laterales para fijar las mesas incluso a media carga. La barra pivota en una de las barandillas para dejar acceso libre hasta el fondo del carro para facilitar la carga.



Barre bloquante se déplaçant le long des rampes latérales afin de fixer les tables, y compris en demie charge. La barre pivote sur une des rampes afin de laisser accès libre jusqu'au fond du chariot et faciliter ainsi le chargement.



Am Rahmen verschiebbare Sicherungsstange zur Sicherung der Tische auch bei halber Wagenladung. Die Sicherungsstange lässt sich an einer Rahmenseite schwenken. Dadurch wird der Zutritt bis zum hinteren Ende des Wagens ermöglicht und das Auf- und Abladen erleichtert.

POWDER
COATED
STEEL



Base with 4° angle of inclination to keep the tables upright when loaded.

Base con 4° de inclinación para mantener las mesas verticales durante la carga.
Support d'une inclinaison de 4°, servant à tenir les tables à la verticale pendant le chargement.
Auflage mit 4° Neigung, um die Tische beim Laden senkrecht zu halten.



Grooved base to prevent the tables from slipping.

Base dentada para evitar que las mesas resbalen.
Support crénelé servant à empêcher que les tables ne glissent.
Gezackte Auflage, damit die Tische nicht verrutschen können.



Four polyurethane wheels with built-in brake. (Two fixed wheels and two pivoting wheels).

4 ruedas de poliuretano con freno incorporado (2 ruedas fijas y 2 ruedas pivotantes).
4 roulettes en polyuréthane avec frein intégré. (2 roulettes fixes et 2 roulettes pivotantes).

4 PU-Räder mit integrierter Bremse. (2 feststehende Räder und 2 Schwenkräder).

Compositions

composiciones / compositions / zusammenstellungen



Compositions

composiciones / compositions / zusammenstellungen



XLAngle + XL4/XL6/XL8



XLAngle + XL4 / XL6 / XL8



XLAngle + XL4 / XL6 / XL8



XL4/XL6/XL8



XLcrescent + XL4/XL6/XL8









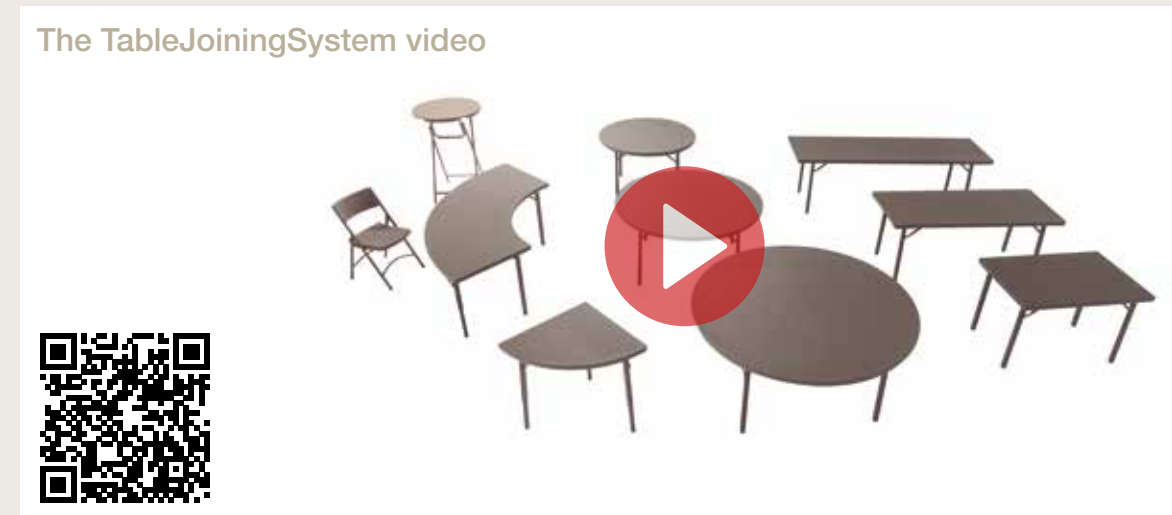

XLAngle + XL4 / XL6 / XL8



XLcrescent + XL4/XL6/XL8



Name Nombre Nom Name	Code Código Code Code	EAN	Product size Medidas product Dimensions emballage Verpackungsmaße	Net weight Peso neto Poids net Nettogewicht	Units per box Unidades por caja Unités par boîte Stückzahl pro Packung	Packaging size Medidas embalaje Dimensions emballage Verpackungsmaße	Gross weight Peso bruto Poids brut Bruttogewicht	Packaging volume Volumen embalaje Volume d'emballage Verpackungsvolumen	Loading quantity Unidades por contenedor Unités par conteneur Einheiten pro Container
XL4									
	BT004X011A	8436539297291	L4' x W30" x H30" L122 x W76.2 x H76.2 cm	25.8 lb 11.7 kg	1	L54.7" x W2.6" x H30.7" L139 x W6.6 x H78.1 cm	30.4 lb 13.8 kg	2.53 ft3 0.071 m3	Container 40': 830 Container 40' HQ: 920
XL6									
	BT006X015A	8436539297130	L6' x W30" x H30" L182.8 x W76.2 cm x H76.2 cm	35.4 lb 16.1 kg	1	L80.3" x W2.6" x H30.7" L204 x W6.6 x H78.1 cm	48.18 lb 21.9 kg	3.63 ft3 0.103 m3	Container 40': 570 Container 40' HQ: 643
XL8									
	BT008X007A	8436539297123	L8' x W30" x H30" L243.8 x W76.2 cm x H76.2 cm	22.1 kg 48.6 lb	1	L104" x W2.6" x H30.7" L264.1 x W6.6 x H78.1 cm	56.9 lb 25.8 kg	4.8 ft3 0.136 m3	Container 40': 360 Container 40' HQ: 510
XLAngle									
	PT013X002A	8436539297307	L30" x W30" x H30" L76.2 x W76.2 x H76.2 cm	9.4 lb 4.3 kg	2	L34.2" x W4.6" x H33.7" L86.9 x W11.7 x H85.7 cm	22.8 lb 10.36 kg	3.07 ft3 0.087 m3	Container 40': 1.320 Container 40' HQ: 1.540
XLcrescent									
	PT015X002A	8436539297314	L7.75" x W40.2" L236x W102.3 x H76.2 cm	41.1 lb 18.7 kg	1	L95.3" x W2.6" x H42.3" L242.2 x W6.6 x H107.6 cm	51.5 lb 23.4 kg	6.07 ft3 0.172 m3	Container 40': 288 Container 40' HQ: 374
XLtrolley									
	RA-102A	8437009886038	L(76"+24") x W30.3" x H45.3" L(193+61) x W77 x H115 cm	65.22 lb 29.58 kg	1	L78" x W34.2" x H6" L198.1 x W87 x H15.2 cm	77.95 lb 35.35 kg	9.252 ft3 0.262 m3	Container 40': 229 Container 40' HQ: 255
Planet4									
	BT048X005A	8436539297277	L4' x W30" x H30" L122 x W76.2 x H76.2 cm	33.8 lb 15.3 kg	1	L49"xW2.7"xH49.3" L124.4xW6.9xH125.4 cm	40.2 lb 18.3 kg	3.77 ft3 0.107 m3	Container 40': 442 Container 40' HQ: 620
Planet5									
	BT060X007A	8436539297260	L5' x W30" x H30" L152.4 x W76.2 x H76.2 cm	46.2 lb 21 kg	1	L61.1" x W2.7" x H61.3" L155.2 x W6.9 x H155.8 cm	56 lb 25.4 kg	5.85 ft3 0.166 m3	Container 40': 320 Container 40' HQ: 351

Name	Code	EAN	Product size	Net weight	Units per box	Packaging size	Gross weight	Packaging volume	Loading quantity
Nombre	Código		Medidas product	Peso neto	Unidades por caja	Medidas embalaje	Peso bruto	Volumen embalaje	Unidades por contenedor
Nom	Code		Dimensions emballage	Poids net	Unités par boîte	Dimensions emballage	Poids brut	Volume d'emballage	Unités par conteneur
Name	Code		Verpackungsmaße	Nettogewicht	Stückzahl pro Packung	Verpackungsmaße	Bruttogewicht	Verpackungsvolumen	Einheiten pro Container

Planet6

	BT072X001A	8436539297116	ø6' x H30" ø182.8 x H76.2 cm	65.2 lb 29.6 kg	1	L73.2" x W2.8" x H73.3" L186 x W7.3 x H186.3 cm	79 lb 35.9 kg	8.69 ft3 0.253 m3	Container 40': 235 Container 40' HQ: 259
---	------------	---------------	---------------------------------	--------------------	---	--	------------------	----------------------	---

PlanetTrolley

	RA-106A	8437009886090	L(52"+11.8") x W32.7" x H40.2" L(132+30) x W83 x H102 cm	67.9 lb 30.8 kg	1	135.7 x 87.6 x 12.7 cm 53.5" x 34.5" x 5"	75.9 lb 34.5 kg	5.297 ft3 0.150 m3	Container 40': 396 Container 40' HQ: 460
---	---------	---------------	---	--------------------	---	--	--------------------	-----------------------	---

Cocktail30

	PT017X002A	8436539297383	ø30" x H43.6" ø76.2 x H110.8 cm	18.48 lb 8.4 kg	1	L55.5" x W2.6" x H30.7" L140.9 x W6.6 x H78.1 cm	22.6 lb 10.3 kg	2.56 ft3 0.072 m3	Container 40': 766 Container 40' HQ: 870
---	------------	---------------	------------------------------------	--------------------	---	---	--------------------	----------------------	---

CocktailTrolley

	RA-277	8437009886809	L47.6" x W35" x H39.6" L121 x W89 x H101 cm	56.2 lb 25.5 kg	1	L118.3 x W92.7 x H12.7 cm L46.6" x W36.6" x H5"	59.18 lb 26.9 kg	4.944 ft3 0.140 m3	Container 40': 380 Container 40' HC: 420
---	--------	---------------	--	--------------------	---	--	---------------------	-----------------------	---



Empresa Homologada por la
Dirección General del Patrimonio del Estado

mobiliar@mobiliar.es
www.mobiliar.es
902 365 064



CENTRAL

C/ La Fragua, 5 • Edificio Mobiliar • Pl. "Los Rosales"
Tel.: 916 656 230 • Fax: 916 641 506
28933 Móstoles (Madrid)

DELEGACIÓN

C/ Pere el Ceremonios, 3 • Nave 2 • Pl. "Masía de Espí"
Tel.: 961 534 064 • Fax: 961 537 790
46930 Quart de Poblet (Valencia)

FÁBRICA

Avda. de las Retamas, s/n • Pl. "Monte Boyal"
Tel.: 918 171 744 • Fax: 918 170 952
45950 Casarrubios del Monte (Toledo)